



Biostorage you can depend on

CONTROLLED **BIOSTORAGE**

# PRICE LIST 2022

Valid from 01.01.2022



## Controlled biostorage

Most people think a fridge is a fridge and a freezer is a freezer. Keeping things cold isn't exactly rocket science, is it?

But in the competitive commercial world of bioscience, there can be huge investments riding on the speed, dependability and success of research work, R&D and biomedical breakthroughs. This means there's an intense focus on fully monitored, controlled storage of the biomaterials at temperatures that are crucial to such operations.

In both commercial bioscience and scientific research, the window of opportunity can be exceedingly limited and development time frames under heavy scrutiny.

High-performance refrigeration and freezer equipment is therefore essential for keeping sensitive, delicate material within meticulously controlled temperature storage parameters.

Gram Commercial is one of the world's prime manufacturers of high-performance refrigeration and freezer equipment for discerning professional users.

We develop, manufacture and market this technology for customers in Europe, the Middle East and Asia, operating from our administration and manufacturing facilities in Denmark. This is all backed by branches in the UK, Germany, the Netherlands, France, Sweden and Norway and distributors throughout the world.

Gram reserves the right to alter prices and specifications.

Valid from 01.01.2022  
[www.gram-bioline.com](http://www.gram-bioline.com)  
[www.gram-biobasic.com](http://www.gram-biobasic.com)



## CONTENT

The Gram BioLine advantage .....	4	<b>BioCompact II .....</b>	<b>52</b>
“Caring products” policy .....	6	BioCompact II RR 210 .....	54
Control Unit – Gram MPC 4.6 .....	7	BioCompact II RF 210 .....	55
ATEX .....	8	BioCompact II RR 310 .....	56
Applications.....	9	BioCompact II RF 310 .....	57
Customised to your needs.....	12	BioCompact II RR 410 .....	58
BioLine options.....	14	BioCompact II RF 410 .....	59
		BioCompact II RR 610 .....	60
		BioCompact II RF 610 .....	61
		BioCompact II RR 210 / RF 210 .....	62
		BioCompact II RR 310 / RF 210 .....	63
<b>ExGuard.....</b>	<b>16</b>		
<b>BioUltra UL 570.....</b>	<b>20</b>		
<b>BioPlus.....</b>	<b>24</b>		
BioPlus ER 500 .....	26	<b>Models and options .....</b>	64
BioPlus RF 500 .....	27	Products and Prices - ExGuard.....	66
BioPlus ER 600 D .....	28	Products and Prices - BioUltra/BioPlus.....	67
BioPlus RF 600 D .....	29	Products and Prices - BioMidi.....	68
BioPlus ER 600 W .....	30	Products and Prices - BioCompact II.....	69
BioPlus RF 600 W .....	31	Codes • ExGuard/BioUltra/BioPlus/BioMidi... ..	70
BioPlus ER 660 D .....	32	Codes • BioCompact II .....	71
BioPlus RF 660 D .....	33	Power consumption index .....	72
BioPlus ER 660 W .....	34	Module definition .....	75
BioPlus RF 660 W .....	35	Dimensions, drawers and shelves.....	76
BioPlus ER 930 .....	36	Loading heights.....	77
BioPlus RF 930 .....	37	Dimensions, cabinets .....	78
BioPlus ER 1270.....	38		
BioPlus RF 1270.....	39	<b>BIOBASIC.....</b>	<b>85</b>
BioPlus ER 1400.....	40		
BioPlus RF 1400.....	41		
BioPlus EF 600 W.....	42		
BioPlus EF 660 W.....	43		
<b>BioMidi .....</b>	<b>44</b>		
BioMidi RR 425.....	46		
BioMidi RF 425.....	47		
BioMidi RR 625.....	48		
BioMidi RF 625.....	49		
BioMidi EF 425 .....	50		

## Gram Commercial - constantly moving forwards...

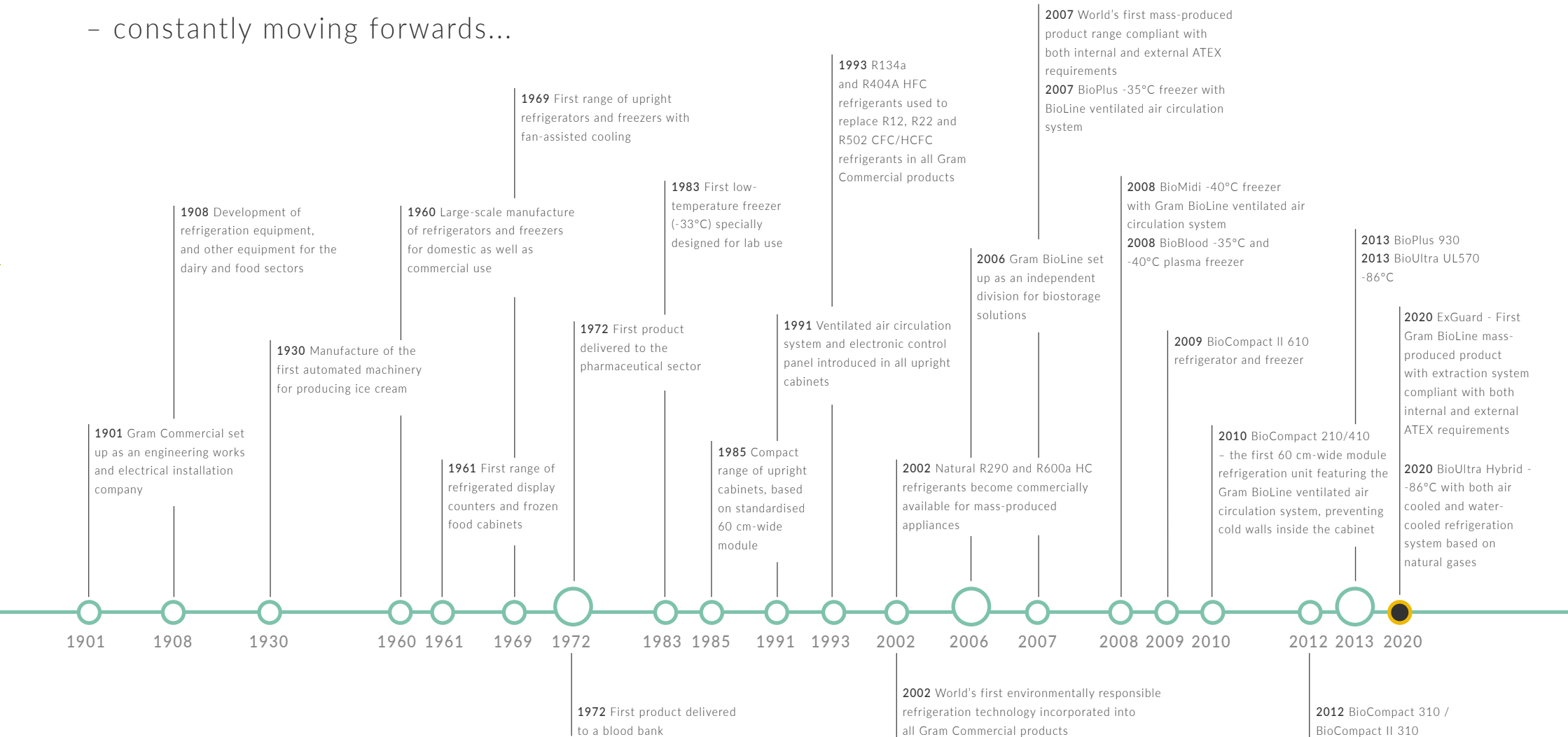

## The Gram BioLine advantage

Appearances can be deceptive. The basic box shape is just about the only thing that Gram BioLine controlled biostorage solutions have in common with the household fridges and freezers that we're all familiar with.

The Gram BioLine range also features significantly higher performance and considerably more demanding specifications than any commercial refrigeration and freezer equipment. We have designed, fine-tuned and optimised all the details in BioLine biostorage cabinets to ensure:



- >> maximum reliability
- >> stringent control
- >> optimised air flows
- >> a responsible environmental profile
- >> easy customisation
- >> rapid support from trained staff

This all means you can rely on every product in our Gram BioLine range to meet and exceed any current legislative requirements and international standards, right across the board. There are six entirely separate models in the Gram BioLine range of controlled biostorage solutions. Together, these cover everything from high-specification biostorage designed for "mission-critical" work to general-purpose refrigeration and freezer units.

Refrigerators		Temp.
RR	Regular refrigeration	+2/+20°C
ER	Extended refrigeration	-2/+20°C
Freezers		
RF	Regular freezer	-25/-5°C
EF	Extended freezer	-35,-40/-5°C
UL	Ultra low freezer	-86/-60°C



ER600W

### ExGuard

Refrigerator -2/+20°C

By connecting the ExGuard refrigerator to an exhaust system the interior air is evacuated prior to allowing access to the cabinet interior facilitating a safe user and work environment.

Furthermore the ExGuard is internal and external ATEX Cat. 2 Zone 2 compliant. ExGuard is available as a full-height extended refrigerator with a capacity of 614 litres.



UL570

### BioUltra

Freezer -86/-60°C

The BioUltra is our ultra-low-temperature cabinet, designed to meet exceptional expectations for safe storage. It has a powerful bottom mounted cascade refrigeration system, vacuum insulated panel technology and a safe closing system constituted by multi-tier gaskets placed in a labyrinth frame. The BioUltra is available as a full-height unit with a capacity of 570 litres.



ER and RF500  
ER and RF600D  
ER and RF600W  
ER and RF660D  
ER and RF660W  
ER and RF930  
ER and RF1270  
ER and RF1400  
EF 600W and 660W

## BioPlus

**Refrigerators -2/+20°C**  
**Freezers -25/-5°C or -35/-5°C**

This is our most advanced model, specifically designed to meet even the most stringent biostorage requirements. The compressor is mounted on top of the cabinet, and the interior is made entirely of stainless steel. BioPlus cabinets are available as full-height units with six different capacities in the range 500–1400 litres.



RR and RF425  
RR and RF625  
EF425

## BioMidi

**Refrigerators +2/+20°C**  
**Freezers -25/-5°C or -40/-5°C**

This is our mid-range model, designed to comply with demanding biostorage requirements. The compressor is mounted at the base of the cabinet, and the interior sides are made of aluminium or stainless steel. All BioMidi models feature a high-specification control system. BioMidi cabinets are available as full-height units with capacities of 425 or 625 litres.



RR and RF210  
RR and RF310  
RR and RF410  
RR and RF610  
RR210/RF210  
RR310/RF210

## BioCompact II

**Refrigerators +2/+20°C**  
**Freezers -25/-5°C**

The BioCompact II design is a general-purpose cabinet that features a ventilated cooling system. BioCompact II cabinets feature the same high-specification control system as the BioMidi model. BioCompact II cabinets are available from full-height to under-the-counter models, with capacities of 125, 218, 250, 343, 346 or 583 litres.



RR and RF210  
RR and RF310  
RR and RF410  
RR and RF600

## BIOBASIC

**Refrigerators +2/+15°C**  
**Freezers -25/-5°C**

The BIOBASIC is designed and manufactured to provide general purpose storage solutions for laboratory applications. BIOBASIC cabinets are available from full-height to under-the-counter models, with capacities of 125, 218, 346 or 610 litres.

# Introducing the Gram BioLine “Caring products” policy

## We listen to your priorities

At Gram BioLine, we work with governments, NGOs, public-sector health and research bodies, and major corporations throughout the world, and we listen to what our customers want, and what their priorities are.

Product requirements such as low energy consumption and a “green profile” – once game-changing – are now just prerequisites. An organisation that takes environmental responsibility seriously now expects any equipment supplier to make sure its products have minimal environmental impact.

## Get serious

That’s why we go beyond providing biostorage equipment with the best performance and low energy consumption. Doing everything we can to provide customers and partners with extensive documentation for what, and how we do it. We call this the Gram BioLine “Caring products” policy.

## Leading from the front

In the world of refrigerators and freezer cabinets, biostorage systems are at the very forefront of new technologies, new standards and new capabilities. We’re constantly introducing new solutions, and Gram BioLine cabinets are widely considered the benchmark for what is possible.

We’ve also made a clear decision to continue manufacturing our products at Gram BioLine facilities in Scandinavia. This is because the Scandinavian rules and regulations regarding environmental responsibility and working conditions are among the most stringent in the world – and these are the only kind of standards we’re interested in.

## Design thinking

An important part of our “Caring products” policy stems from focusing on designing every feature to perform its role with maximum benefit for the user. Every innovative feature we include is developed and fine-tuned by multidisciplinary teams, and assessed by external focus groups consisting of both users and other interested parties.

Our design work also involves considering the work conditions of the people who use our products. We aim to make sure that users’ well-being is taken into account at every stage, so day-to-day use becomes a comfortable convenience.

## Pledge for longevity – Spare parts availability

A pivotal point of our “Caring products” policy is to provide the best possible service to our customers, part of this of the being the serviceability and availability of spare parts for our products. Acknowledging the value of keeping products in service, we guarantee the availability of spare parts for at least 10 years after initial purchase of the product.

## Documentation is key

In a world where requirements for biostorage systems are increasing, the demand for documentation is following suit, and has in many cases become a prerequisite. Acknowledging a more holistic approach to biostorage systems, and in junction with our “Caring products” policy, we continually strive to provide the highest degree of documentation for our products.

## Going beyond the conventional – IQ, OQ, PQ

Going against the industry standard, we have opted for the high-road. Making extensive IQ, OQ, PQ-documentation readily available for our customers. This goes hand-in-hand with market demand, and our views on “how it should be”. Find IQ,OQ,PQ documentation along with manuals on our website.

## ISO 9001

Quality is one thing, “Quality management” is another. Gram BioLine ensures and recognizes in a literal fashion that quality management – with inherent risk management, product traceability and process validation – is of the utmost importance. With 9001 certification, Gram BioLine cabinets reap the fruits of a comprehensive array of quality management systems.

## ISO 14001

Gram BioLine has been awarded the stringent ISO 14001 approval as a result of continued improvement of its Environmental Management Systems and practices. Attaining the internationally accepted standard represents the achievement of maintaining profitability whilst reducing the environmental impact in the daily operation of all aspects of the organisation.

## EC Declaration of Conformity

Find the standards, guidelines and directives we comply with in our declarations of conformity, freely available for all our products on our website under «Documentation».

# Control Unit – Gram MPC 4.6

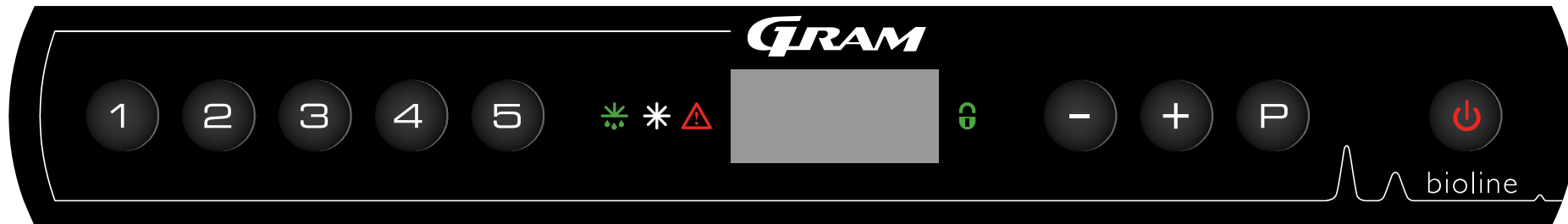

The MPC 4.6 control unit was specially developed for users of Gram BioLine storage cabinets. Decades of experience blended with the best of modern technologies provide a uniquely capable control unit.

**Temperature alarm\*** – Provides visual and acoustic alarms if the temperature exceeds the designated temperature limits. High and low alarm limits can be set separately, and the time delay before the alarm goes off can also be adjusted.

**Highest/lowest temperature logging\*** – Logging of maximum and minimum temperatures in the period since these were last reset. The designated reference sensor can be either the room sensor (A-sensor) or the extra sensor (E-sensor).

**Temperature history\*** – Records time and temperature if the upper or lower temperature limits set by the customer are exceeded. Records the total period of time during which the upper or lower temperature limits were exceeded, as well as the maximum or minimum temperatures reached in excess of those limits. The display flashes if the temperature history function has been activated.

**E-sensor\*** – Extra sensor placed inside the storage space makes it possible to measure temperatures in the materials stored inside, or in a simulated substance. The E-sensor can be designated as the reference point for all temperature alarms.

**Voltage-free output** – Provides a remote alarm in case of power failure, door alarm or temperature alarm, with separate delay.

**Offset** – Temperature sensors can be adjusted separately.

**Door alarm** – Provides an acoustic and visual alarm if the door is open longer than the set delay or if the door is left ajar. This alarm can be set with individual delays. Does not apply for BioUltra.

**Key pad lock** – The display can be locked using a code. This ensures that nobody can change the settings or accidentally turn off the cabinet power supply.

**Display** – Easy-to-read LED display with soft-touch buttons.

\* Applicable to BioUltra, BioPlus, BioMidi and BioCompact II

# ATEX

ATEX is a French abbreviation for “ATmosphère EXplosif” – and is the only European set of regulations (ATEX directive 2014/34/EC) for equipment intended for use in potentially explosive atmospheres. The intentions behind ATEX are to improve the working environment and provide better protection for both staff and the surrounding environment against danger and the risk of damage as a result of equipment or installations that could ignite any flammable atmosphere that might be present.

The ATEX requirements differ from the vast majority of regulations relating to the Low Voltage Directive (LVD) in not only taking electric components into consideration, but also involving materials, moving parts, instructions for use, labelling, etc.

ATEX thus provides an all-round assessment of the complete product with a view to ensuring greater safety for the user and better protection for the environment. This also means Gram BioLine storage cabinets represent a solid investment in a safe, environmentally responsible future.

## The Gram BioLine ATEX benefit

The Gram BioLine range of biostorage cabinets provides you with full ATEX compliance – both internal and external – at no extra charge. Gram BioLine is currently the only supplier capable of providing both internal and external ATEX compliance for a refrigerator or freezer in serial production.

Gram BioLine units comply with the EN/IEC 60079-15 standard, which covers electrical apparatus for use in Category 3, Zone 2 locations where explosive gas atmospheres may be present.

This means you can place any Gram BioLine cabinet in a Zone 2 area categorised according to EN/IEC 60079-10. The key benefit is that you can then position the cabinet within the actual work zone, rather than in some remote location, as would be required with only internal ATEX compliance.

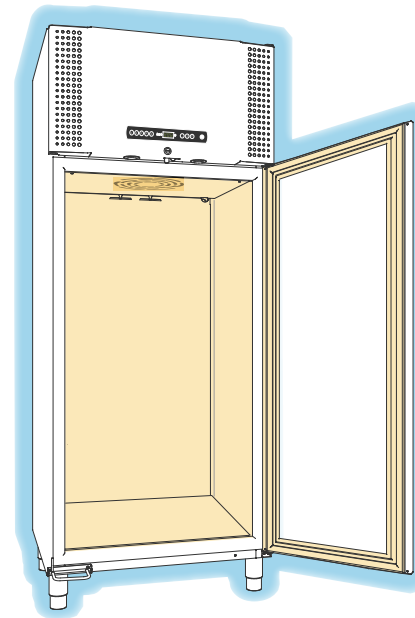

## II 3G EX ec nC Ic IIB T1-T5 Gc

DTI 19ATEX0112X

DTI 19ATEX0113X

DTI 19ATEX0114X

DTI 21ATEX0160X

DTI 21ATEX0161X

## II 3G Ex nA nC nL IIB T1 - T6 Gc

Manufacturer product declarations  
assessed or Certified by Danish  
Technological Institute



## Internal ATEX

The storage space within the cabinet complies with EN/IEC 60079-15 Category 3 Zone 2 requirements. This means the cabinet can be used for storing substances categorised as potentially explosive or with a risk of creating an explosive atmosphere.

## External ATEX

All components that are in contact with the surrounding atmosphere comply with EN/IEC 60079-15 Category 3 Zone 2 requirements. This means the cabinet can be placed in any working area categorised as an explosive atmosphere Category 3 Zone 2 according to EN/IEC 60079-10.



## Introducing “Applications”

Distinguishing between the different model ranges and where they are best suited has become easier. “Application” icons bridge the gap between product ranges and the requirements in the different segments, work environments and use patterns. Allowing for quick and precise evaluation of needs and requirements.



### ATEX

The yellow ATEX application sticker on our different model ranges enables placement in environments with potential explosive atmospheres and storage of substances that can cause potential explosive atmospheres



### GMP “Good Manufacturing Practice”

Models able to comply with the requirements present in GMP areas, where safe storage during manufacturing of food or pharmaceuticals is paramount - ensuring consistently high quality products



### GLP “Good Laboratory Practice”

Complies with the requirements for storing laboratory studies, ensuring the ability to replicate tests consistently (in the protection of man and the environment)



### MEDICINE

Models that are able to comply with the performance and feature requirements, relevant to the safe storage of medicine and vaccines

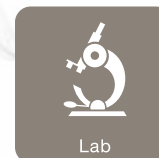

### LAB

Models that are able to comply with the requirements in general purpose storage scenarios such as basic exploratory research or proof of concept studies

## More than the sum of the parts

A wide range of new forward thinking, and technical innovations combine to make Gram BioLine biostorage systems the best-performing solutions currently available.

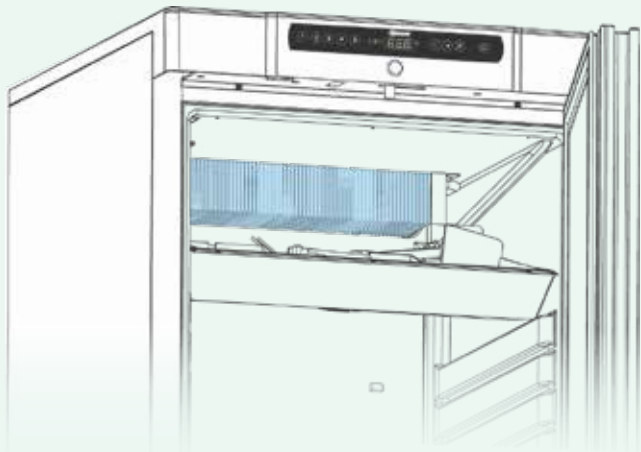

## No cold walls

The refrigeration system based on a finned tube evaporator is the backbone of the range of Gram BioLine products, and provides exceptional benefits compared with other systems.

The design results in a refrigerated storage space with no cold walls that can damage any delicate items stored in the cabinet. When combined with the Gram BioLine air distribution system, it also ensures even better temperature stability inside the cabinet.

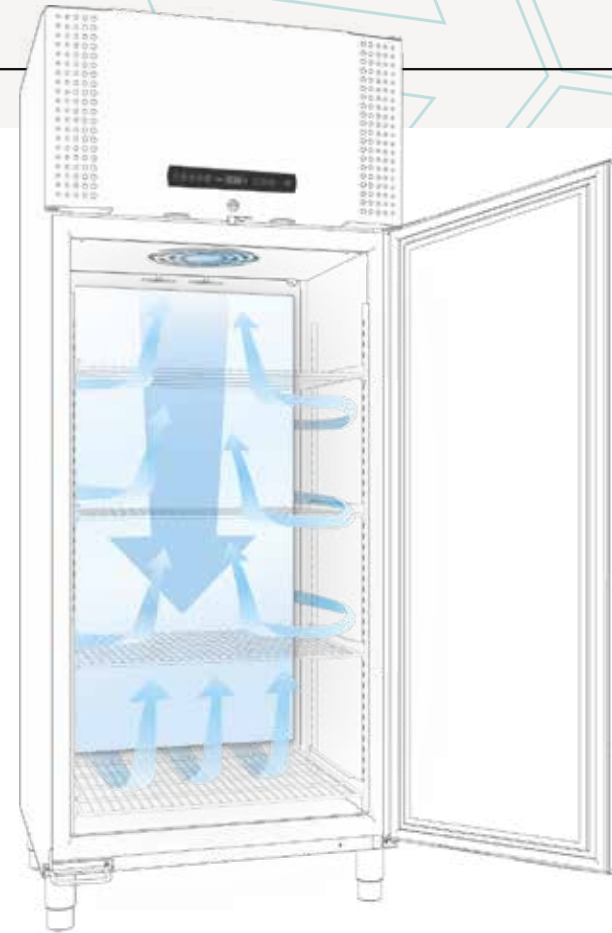

## Optimised air flow

The unique Gram BioLine air distribution system leads a flow of cold air down a special distribution plate at the back of the cabinet interior. This air is then forced around inside the cabinet while it is moved upwards to the evaporator fan mounted in the top. This ensures the temperature is consistent everywhere in the cabinet and that the time taken to return to the programmed temperature after a door has been opened is very short. This helps keep energy consumption to a minimum.

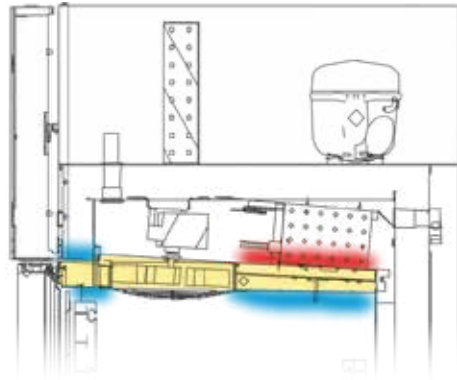

- Insulation
- Heated surface during defrost period
- Safe cold surface during defrost period

## Temperature management

All Gram BioLine refrigerated units feature the “Smart defrost” automatic defrost function, and the freezers (BioPlus and BioMidi) are also equipped with a defrost shield, which is an insulated separation between the storage compartment and the electric defrost element that is used during defrosting, if needed.

This ensures that only a minimum of heat is released into the storage compartment when the system is defrosting, keeping any temperature peaks to an absolute minimum. The surface that leads the defrost water out of the cabinet for re-evaporation is heated very gently to prevent any build-up of ice and to ensure the continuous safe running cycle of the cabinet.

## Controlled defrosting

Gram BioLine “Smart defrost” is an advanced automatic defrosting function. Unlike conventional defrosting systems where the user has no control of the defrost cycle, this intelligent automatic system makes sure an absolute minimum of time and energy is used during each individual defrost cycle, by calculating the required time and energy necessary based on the actual condition of the refrigeration system. Smart defrost lets the user determine frequency of defrost cycles, thus providing the user with full control over the defrosting function.

## Safer biostorage

These many exceptionally innovative effective features combine to provide the most effective and efficient biostorage solutions on the market today – cabinets that are also the most practical and convenient for the user.

The sum of all these technical innovations results in supreme temperature stability inside the cabinet [1], with greatly reduced temperature peaks during defrosting [2].

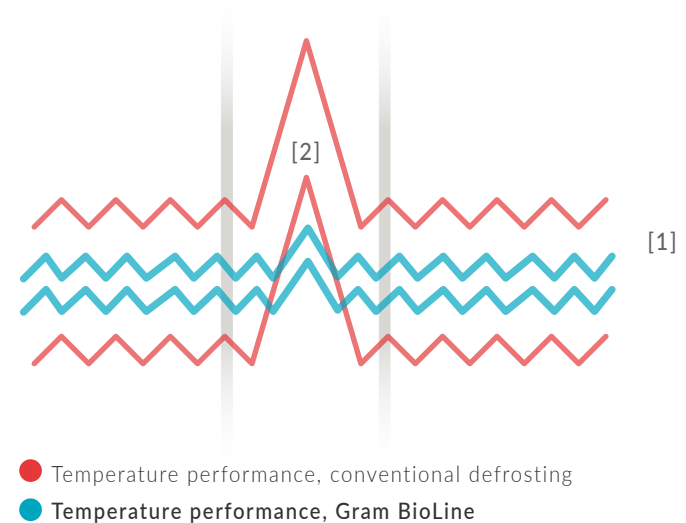

# Configuration

How to configure and customise your particular Gram BioLine biostorage cabinet

## Customised to your needs

Each single user has a unique set of requirements for how a biostorage fridge or freezer should be configured, and how the interior should be laid out.

That's why there are no standard arrangements for cabinets in the Gram BioLine range – it'd be highly unlikely that "standard" would live up to your particular working requirements.

Our approach is to make sure that all the Gram BioLine cabinets featured in this price list have a high standard specification. We then provide you with a comprehensive selection of optional features, as well as standardised modules for internal arrangements, fittings and accessories.

These choices enable you to select exactly what you need and to customise both the operating specifications and the interior layout of your Gram BioLine cabinets, «so that they are in line» with your particular requirements.



### 1. Select model

BioUltra, BioPlus, BioMidi or BioCompact II and cabinet size (210, 310, 410, 425, 500, 570, 600, 610, 625, 660, 930, 1270 or 1400)

BioPlus 600D	
--------------	--

### 2. Select exterior

– select between white lacquered steel or stainless steel

White	
-------	--

### 3. Select temperature range

– select refrigerators RR or ER or freezers RF or EF

ER	
BioPlus ER 600D White	€ 4,840

### 4. Select door

– solid insulated doors for refrigerators and freezers, or double-layer energy-optimised glass doors for refrigerators.

Doors are selected to be hinged on either the right or the left (single door units only)

Glass door, right hand hinged	€ 230
-------------------------------	-------

### 5. Select interior

– from a wide range of versatile interior fittings including shelves, drawers, reference container, low temperature protection, chart recorder, wall mounting etc.

6 wire shelves in stainless steel	€ 330
Low temperature protection	€ 135
Reference container	€ 30

### 6. Select base

– select between legs, wheels or prepared for mounting on plinth

Legs	€ 0
------	-----

Customised cabinet	€ 5,565
--------------------	---------

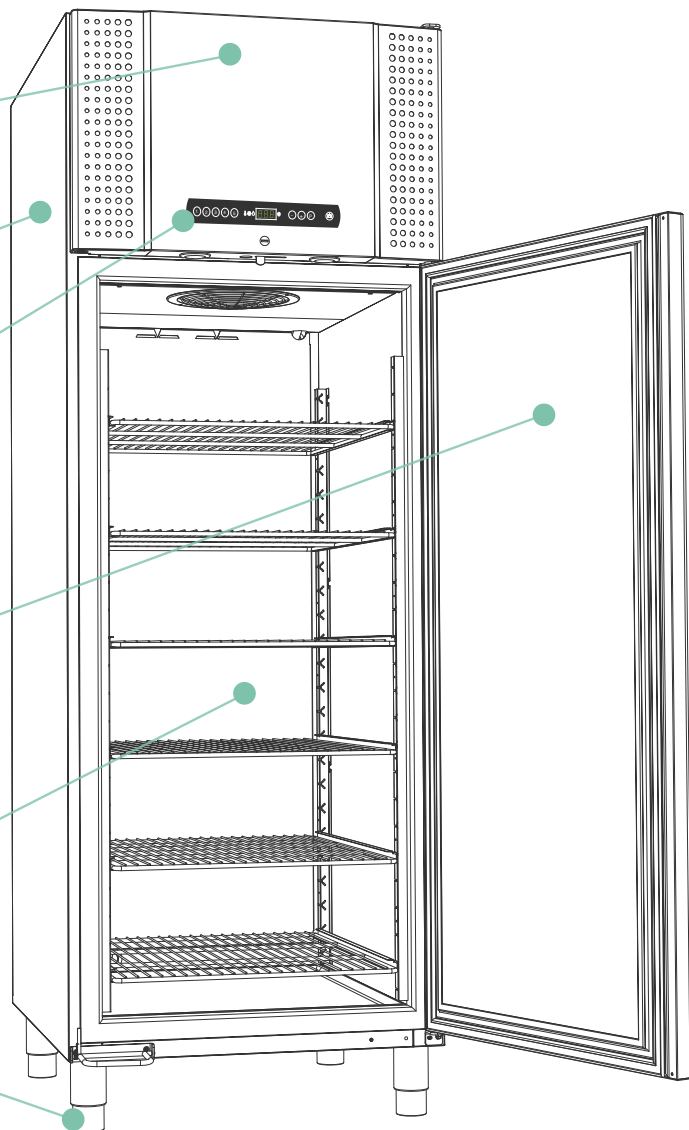

## When your needs change

Configuring a Gram BioLine cabinet to your current requirements doesn't lock you in to those specifications for ever. If new requirements arise or you need to change the way your staff use the cabinet, you can easily reconfigure it to meet those changing needs. All the fixtures and fittings inside Gram BioLine cabinets are based on the same modular system, making it easy to install new and/or different equipment to replace interior fittings that no longer meet your current requirements.

Gram BioLine "factory-fitted" items are the extra equipment and fittings you can select when the cabinet is delivered new from the factory.

Gram BioLine "supplied separately" items are the additional equipment and fittings you can purchase to supplement or alter the capabilities and layout in your existing Gram BioLine cabinets.

See page 66-69 - Products and prices for detailed information

	Factory-fitted	Supplied separately
<b>Additional equipment and fittings</b>		
BioLine aluminium drawer with length and cross dividers .....	€ 165	€ 195
BioLine stainless steel drawer 30 kg .....	€ 165	€ 195
BioLine stainless steel drawer 40 kg .....	€ 220	€ 250
BioLine dividers for stainless steel drawers (1 set).....	€ 60	€ 90
BioLine perforated shelf in stainless steel.....	€ 80	€ 100
BioLine wire shelf in stainless steel.....	€ 55	€ 75
BioLine wire shelf with plastic coating .....	€ 40	€ 60
Door hinge - on right or left side.....	€ 0	N/A
Legs, castors/wheels or for mounting on a plinth .....	€ 0	€ 110
Castors, 360° swivel .....	€ 40	€ 150

# BioLine options

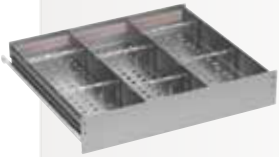

## Aluminium drawers

Specially built, multi-purpose drawers provide a high degree of flexibility for your biostorage. The drawers can be divided horizontally and vertically according to your specific needs and changing daily requirements.



## ABS drawers

The ABS drawer has been designed from the ground up to meet the most stringent requirements. The drawer is one-piece injection molded for maximum rigidity and seamless smooth surfaces. Available for Biocompact II 210, 310 and 410 models.



## Stainless drawers 30 / 40 kg

High-quality, heavy-duty drawers made of stainless steel are well-suited for use in particularly demanding environments. These drawers are available with a traditional stainless steel front. Equipped with telescopic drawer rails.

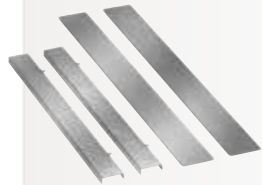

## Stainless dividers

Divider system for when additional vertical compartments are needed in 30 and 40 kg stainless steel drawers.



## Wire shelves

The high-quality standard wire shelves are constructed of robust stainless steel for long life. Plastic-coated wire shelves are available for general use.

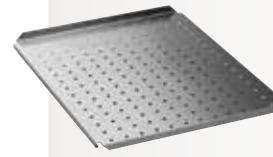

## Stainless perforated shelves

The perforated shelves provide a flat surface that helps ensure stable storage. The special design ensures exceptional strength, making them ideal for bearing heavy items. These shelves are highly resistant to a wide range of substances.



## Wire basket

Large wire basket mounted in u-shaped rails fitted into the walls of the cabinet. Ideal for storing multiple items, with easy access. Available for BioCompact II 210, 310 and 410 models.



## Glass doors

These make checking and access both quicker and easier. Fitted with an energy-saving, extra-insulated double layer of glass, the glass door is optional equipment for the refrigerators in the Gram BioLine range.



## Draught shields

Set of 3 extra inner doors that minimise cold loss when the outer cabinet door is opened. Each of the 3 inner doors can be opened separately for access to the storage compartment. Optional for BioPlus and BioMidi, and standard equipment on EF versions.

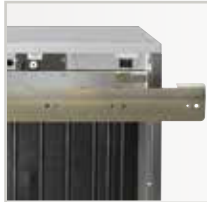

## Wall mounting

BioCompact II 210, 310 and 410 models can also be wall-mounted, to save floor space and for easy cleaning.



## Legs

Adjustable stainless steel legs are the ideal choice for mounting a stationary refrigerator securely and safely. You can also choose to have the refrigerator prepared for mounting on a plinth. Both options are included in the Gram BioLine product range at no extra charge.



## Wheels

A cabinet with wheels provides you with a bio-storage unit you can move around. For an even more manoeuvrable cabinet, you can upgrade from the standard option of two lockable castors and two fixed wheels to the option with four lockable castors.



## Chart recorder

The temperature chart recorder is for independent measurement of cabinet temperature. Sensor can be placed in separate liquid container. The recorder is powered by a 1.5 volt battery to ensure recording even in the event of a power failure.

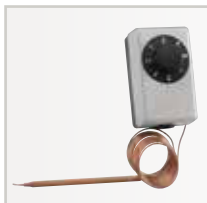

## Low-temperature protection

Low-temperature thermostat preventing the refrigerating system to operate if the temperature falls below the set minimum. This feature cannot be combined with an external compressor.



## Reference container

Container in which the properties of the biomaterial can be simulated. The E-sensor or the user's own sensor can be placed in the reference container.



## DIN kit

Fitted with the appropriate DIN kit, relevant cabinets will be compliant with DIN 58345.



## Pedal door opener

Practical pedal door opener for hand-free opening of the cabinet. Standard for BioPlus and optional available for BioCompact II 410/610.



**Dual refrigeration circuit:** This additional safety feature ensures that the temperature inside the cabinet is maintained even in the unlikely event of a compressor failure. There are two independent refrigeration circuits that operate side-by-side under normal circumstances. However, each is designed to safely maintain the desired cabinet temperature on its own.



## Compressors

If the local energy supply is incompatible with the 230V, 50Hz specification that is standard on BioLine products, you can select a 230V, 60Hz compressor as an alternative.

# ExGuard



Biostorage you can depend on

## Alarm recording

- and Hi/Low temperature read out.

## Voltage-free contact

- for IT networks, monitoring systems and/or remote alarms.

## Acoustic and visual alarm

- provides clear notification if either maximum or minimum permitted temperature is reached. A door alarm is also fitted. All alarm parameters are set separately.

## Extraction controller

- dedicated controller for access management and extraction of cabinet interior.

## Smart defrost

- smart automatic defrosting system with re-evaporation of the defrost water.

## Door lock

- electromagnetic safety lock.

## Extra Sensor

- "E-sensor" for temperature reference in the storage compartment. The E-sensor can be combined with a reference container.

## Hazardous atmosphere extraction mechanism

- allowing hazardous atmospheres to be replaced by ambient air before the door can be opened.

## High-capacity refrigeration unit

- makes sure the interior quickly returns to the specified temperature after the door has been opened. A cooling system prepared for remote compressor is also available.

## Gram BioLine ventilated air circulation system

- featuring a special distributor plate that ensures consistent temperatures everywhere in the cabinet.

## Self-closing

- solid door as standard or well-insulated glass door as an optional extra for refrigerators (ER models).

## Exterior & Interior finish

- made of white lacquered steel or stainless steel.  
- made of stainless steel.

## ATEX

- the Gram BioLine range of biostorage cabinets provides you with full ATEX compliance - both internal and external.

## Interior fittings

- A wide range of versatile interior fittings and layouts are available. The operating specifications and the interior layout can both be customised.

## Access port

- 24.5 mm port for ease of access, e.g. sensors for external temperature surveillance.

## Ambient air intake

- damper allows for ambient air to enter during the extraction process.

## The base

- can be fitted with castors or feet.

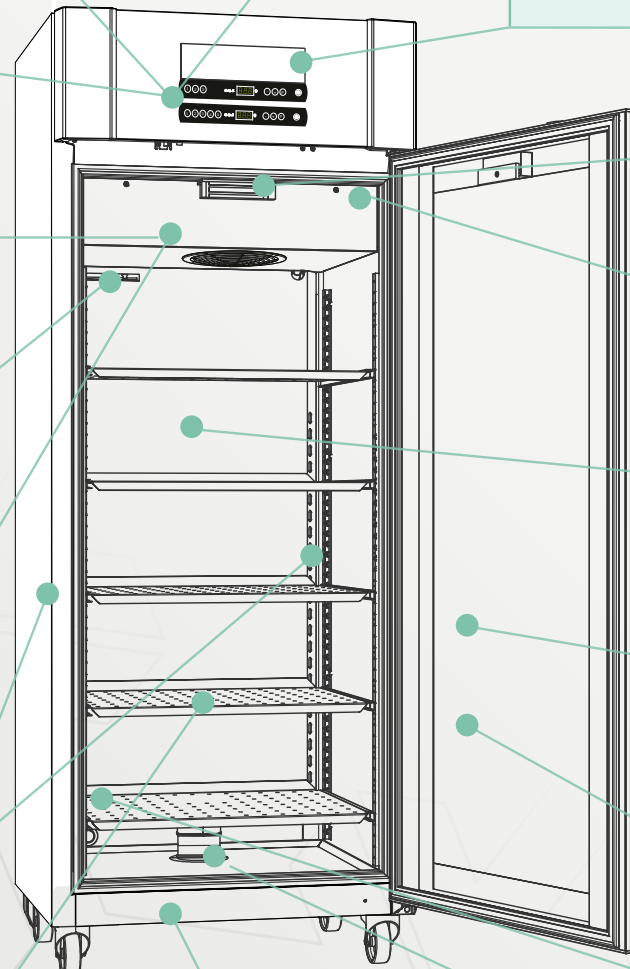





-  ATEX
-  GMP
-  GLP
-  Lab



**EXGUARD**  
YOUR SAFETY

The ExGuard is designed for safe temperature controlled storage of items potentially emitting noxious, malodourous and /or explosive atmospheres. At the core, the ExGuard is envisioned to facilitate a safer work environment for users.

ExGuard increases work environment safety and allows placement in work environments by letting your existing ventilation system extract the hazardous atmospheres from the cabinet interior prior to you being able to access the interior.

As with all other BioLine refrigerators, the ExGuard has internal and external ATEX Cat.3 Zone 2 compliance, thereby keeping the work environment safety as high as possible.

The ExGuard is currently available as a 614 litre refrigerator in stainless/stainless or white/stainless with glass or solid door.

#### ExGuard refrigerator

ER	Extended refrigeration	-2/+20°C
----	------------------------	----------



#### Features include:

- Built in safety mechanisms that prevent the cabinet from being opened before the hazardous atmosphere have been safely extracted
- Effortless and safe daily operation
- ATEX Cat.3 Zone 2 compliant – Internal and External
- Easy connection to your existing ventilation system\*
- Minimal setup
- High capacity refrigeration system for temperature recovery

\*Requirements for airflow dependant on items stored

## ExGuard, work safety made accessible

Safe temperature controlled storage of items potentially emitting noxious, malodourous and /or explosive atmospheres has until now been difficult. An option has been to customize a cabinet with extensive additions to comply with requirements - or in the worst case, using a regular storage cabinet for hazardous atmospheres, exposing users and surroundings to potential harm.

The ExGuard line offers a safe and viable storage solution for items potentially emitting noxious, malodourous and /or explosive atmospheres. With external and internal ATEX Cat. 3 Zone 2 compliance, integrated extraction controller, user safety features and fail-safes - ExGuard simply needs to be connected to an existing ventilation system and power supply to deliver a market benchmark for practical obtainable safety in the workplace.

### Easy to use

The ExGuards simple access procedure requires minimal training and ensures safe access to the stored items every time.

- A powerful electromagnetic lock keeps the cabinet door firmly locked under ordinary operation
- To access the cabinet, press the activation button on the extraction controlpanel. The cabinet interior will be evacuated and flushed with ambient air
- After a successful extraction, the cabinet can be opened
- When the cabinet is closed, the door is automatically locked

A damper is controlled via the extraction controller to open and close, allowing for potentially contaminated air to be evaluated through the connected ventilation system.



Ambient air is drawn into the cabinet interior through a check valve when the damper opens, equalising the pressure in the interior thereby flushing out potentially contaminated air.



# ExGuard ER600W



**Ex II 3G Ex ec nC ic IIB T1 Gc  
DTI 19ATEX0113X**

Price (white)  
**€ 6,990**

Price (stainless steel)  
**€ 7,240**

Technical specifications	
Temperature range	-2/+20°C
Ambient temperature range	Solid door +10/+43°C; glass door +10/+38°C
Control Unit	Dedicated ExGuard extraction controller and software inhibiting access to the storage chamber unless safe extraction of cabinet interior has occurred. Timing of steps in the access procedure can be adjusted to suit your specifications. Separate controller managing normal operation as with the BioPlus range.
Material: Interior Exterior	Stainless steel White lacquered steel or stainless steel
Ext. dimensions mm (W x D x H):	820 x 789 x 1996/2246
Net weight	Unpackaged net weight without optional fittings: 166 kg
Gross volume	614 litres
Net volume	486 litres
Modules for shelves and drawers	48 max (see page 76)
Insulation	70 mm polyurethane with HFC-free cyclopentane propellant
K-Value	Solid door 0.2685 W/m <sup>2</sup> K; glass door 0.4530 W/m <sup>2</sup> K
Refrigerant	R290
CO <sub>2</sub> e	-
Refrigeration capacity at -10°C	R290 389 watt
Energy consumption	1.62 kWh/24h
Connection	230 V, 50 Hz
Sound level	46,3 db(A)
Air system	Gram BioLine ventilated air distribution system
Defrost system	Automatic smart defrost with re-evaporation of the defrost water

## Optional fittings and equipment – product configuration guide on page 12

S	BioLine stainless steel drawer 40 kg	€ 220	11	Glass door	€ 230		
C	BioLine dividers for stainless steel drawers (1 set)	€ 60	V	Reference container	€ 30		
P	BioLine perforated shelf in stainless steel	€ 80		** Legs, wheels	€ 0		
T	BioLine wire shelf in stainless steel	€ 55	31	Castors, 360° swivel	€ 40		
			20/21	Door hinge – on right or left side	€ 0		

\*\* See page 78

Option codes

# BioUltra UL570



Biostorage you can depend on

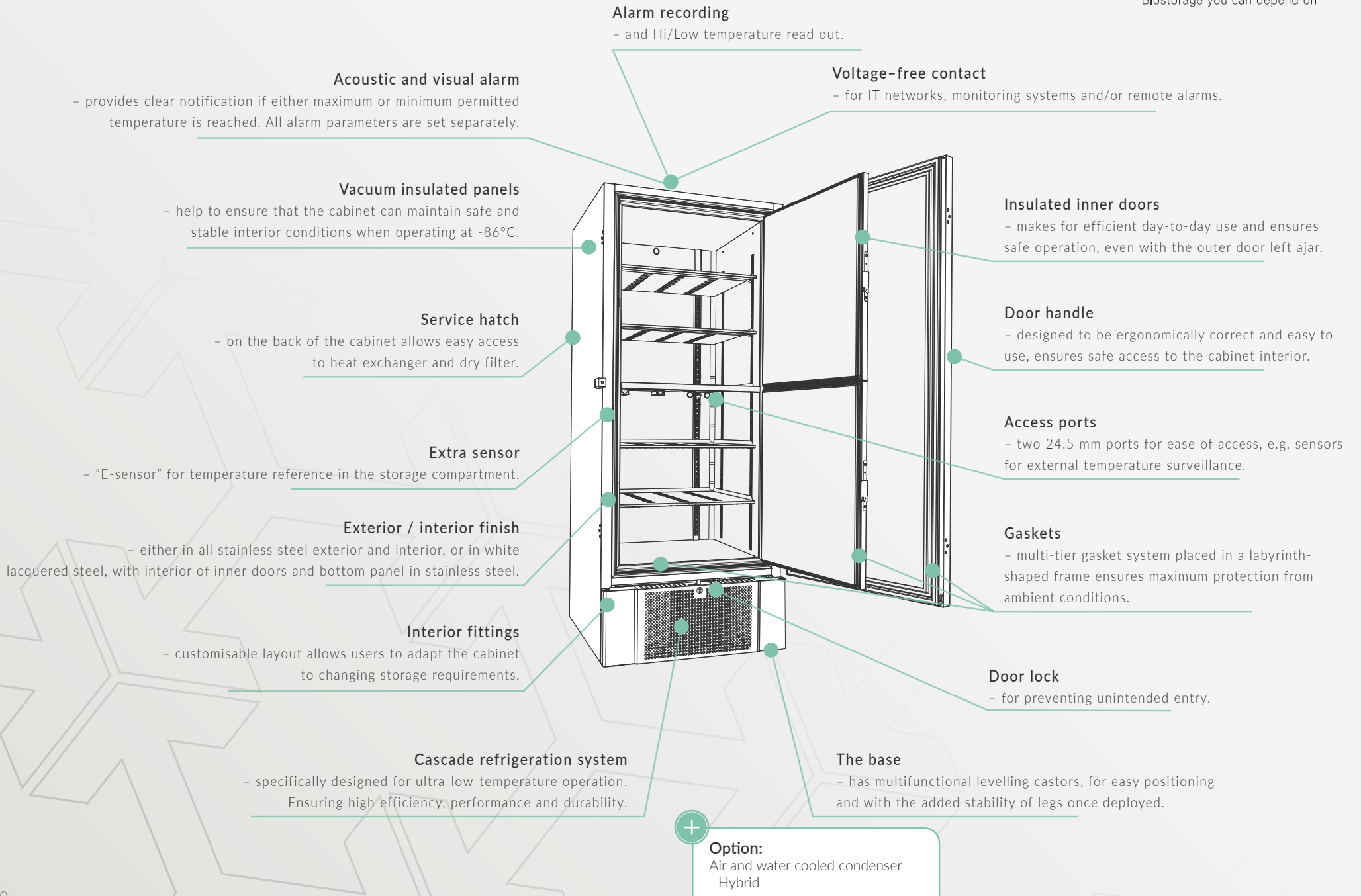

# BioUltra UL570



The BioUltra UL570 is an ultra-low-temperature freezer that operates safely at -86°C.

By utilising high-capacity components, cascade refrigeration system, latest generation vacuum insulated panel technology and insulated inner doors, the BioUltra cabinets are able to maintain safe and stable interior conditions when operating at -86°C.

The BioUltra UL570 holds up to 384 2"/50 mm boxes, 192 3"/75 mm boxes or 192 4"/100 mm boxes.

BioUltra freezers		
UL	Ultra Low Freezer	-86/-60°C

- ① The Gram MPC 4.6 control unit lets you adjust several different parameters individually. This makes it easy to adjust the cabinet's operating profile to your specific requirements or changing needs.
- ② Each UL570 is delivered with five adjustable stainless steel perforated shelves, for full utilisation of the storage space.
- ③ Two separate insulated inner doors facilitate safe operation and high flexibility. The inner doors can be removed for easy cleaning.

## INFO

Besides a regular air-cooled condenser, the BioUltra is also available with a hybrid water/air-cooled condenser option\*. The hybrid option combines the convenience of minimal heat and noise emission from water cooling, with the safety of a redundant condensing system in the event of interruptions in the supply of process water - securing maximum item safety and cabinet uptime.



\*Requires process water supply

# BioUltra UL570 ❄️ -86°C

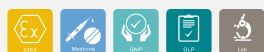

**Ex II 3G Ex ec nC ic IIB T4 Gc**  
**DTI 19ATEX0112X**

Price (white)  
**€ 9,540**

Price (stainless steel)  
**€ 9,990**

Technical specifications	
Temperature range	-86/-60°C
Ambient temperature range	+10/+30°C
Control Unit	Gram Control Unit with voltage-free contact, E-sensor, acoustic temperature alarm that can be programmed individually, alarm recording, hi/low temperature and offset function.
Material: Interior Exterior	White lacquered steel, inside of doors and bottom panel in stainless steel White lacquered steel or stainless steel
Ext. dimensions mm (W x D x H):	856 x 979 x 1986/1996 (min./max. height)
Net weight	Unpackaged net weight without optional fittings: 257 kg
Gross volume	570 litres/20.1 cubic feet
Modules for shelves	Adjustable with 12.5 mm increments 5 Stainless steel perforated shelves come as standard
Rack capacity: 2"/50 mm boxes	384 boxes (using 4x4 racks)   38.400 vials (using 4x4 racks)
Rack capacity: 3"/75 mm boxes	192 boxes (using 3x4 racks)   19.200 vials (using 3x4 racks)
Rack capacity: 4"/100 mm boxes	192 boxes (using 2x4 racks)   19.200 vials (using 2x4 racks)
Insulation	70 mm (HFC free cyclopentane) Vacuum insulated panels
Refrigerant	R404A* & R508B and R601 / R290 & R170 and R601
CO <sub>2</sub> e	R404A: 844 / R508B: 4019
Sensors used	PT-10.000
Base	Levelling castors
Connection	230 V, 50 Hz, 16 Amp
Energy consumption**	12.2 kWh/24h (R404A) / 10.5 kWh/24h (R290)
★ Sound level	<b>49 dB(A) R404A / 46,5 dB(A) R290</b>

## Optional fittings and equipment – product configuration guide on page 12

Equipped with 5 perforated shelves in stainless steel

50	Chart recorder	€ 650	20/21	Door hinge – on right or left side	€ 0		
79	Water cooled condenser - Hybrid	€ 2,035					
82	60 HZ compressor	€ 0					

\* R404A Available outside European Union

\*\* Measured with empty cabinet, setpoint of -80°C with an ambient temperature of 20°C

■ Option codes

Racks					
	Model	Type	Description	HxDxW	Price
2"/50 mm	Eco AluRack	Side opening, aluminium construction	For 4x4 boxes max 137x137mm	228x558x140	€ 85
	Standard rack	Side opening, stainless steel construction	For 4x4 boxes max 137x137mm	228x558x140	€ 95
	Comfort rack	Shuffle rack, stainless steel construction	For 4x4 boxes max 137x137mm	228x558x140	€ 155
3"/75 mm	Eco AluRack	Side opening, aluminium construction	For 3x4 boxes max 137x137mm	240x558x140	€ 85
	Standard rack	Side opening, stainless steel construction	For 3x4 boxes max 137x137mm	240x558x140	€ 95
	Comfort rack	Shuffle rack, stainless steel construction	For 3x4 boxes max 137x137mm	240x558x140	€ 165
4"/100 mm	Eco AluRack	Side opening, aluminium construction	For 2x4 boxes max 137x137mm	212x558x140	€ 85
	Standard rack	Side opening, stainless steel construction	For 2x4 boxes max 137x137mm	212x558x140	€ 95
	Comfort rack	Shuffle rack, stainless steel construction	For 2x4 boxes max 137x137mm	212x558x140	€ 165

\* prices are without boxes

Boxes				
	Box height	Type	Description	Price/pcs.
9x9	2"/50 mm	Coated cardboard, white	133x133mm with 9x9 dividers	€ 4
	3"/70 mm	Coated cardboard, white	133x133mm with 9x9 dividers	€ 5
	4"/100 mm	Coated cardboard, white	133x133mm with 9x9 dividers	€ 7
10x10	2"/50 mm	Coated cardboard, white	136x136mm with 10x10 dividers	€ 4
	3"/70 mm	Coated cardboard, white	136x136mm with 10x10 dividers	€ 5
	4"/100 mm	Coated cardboard, white	136x136mm with 10x10 dividers	€ 7

# BioPlus



Biostorage you can depend on

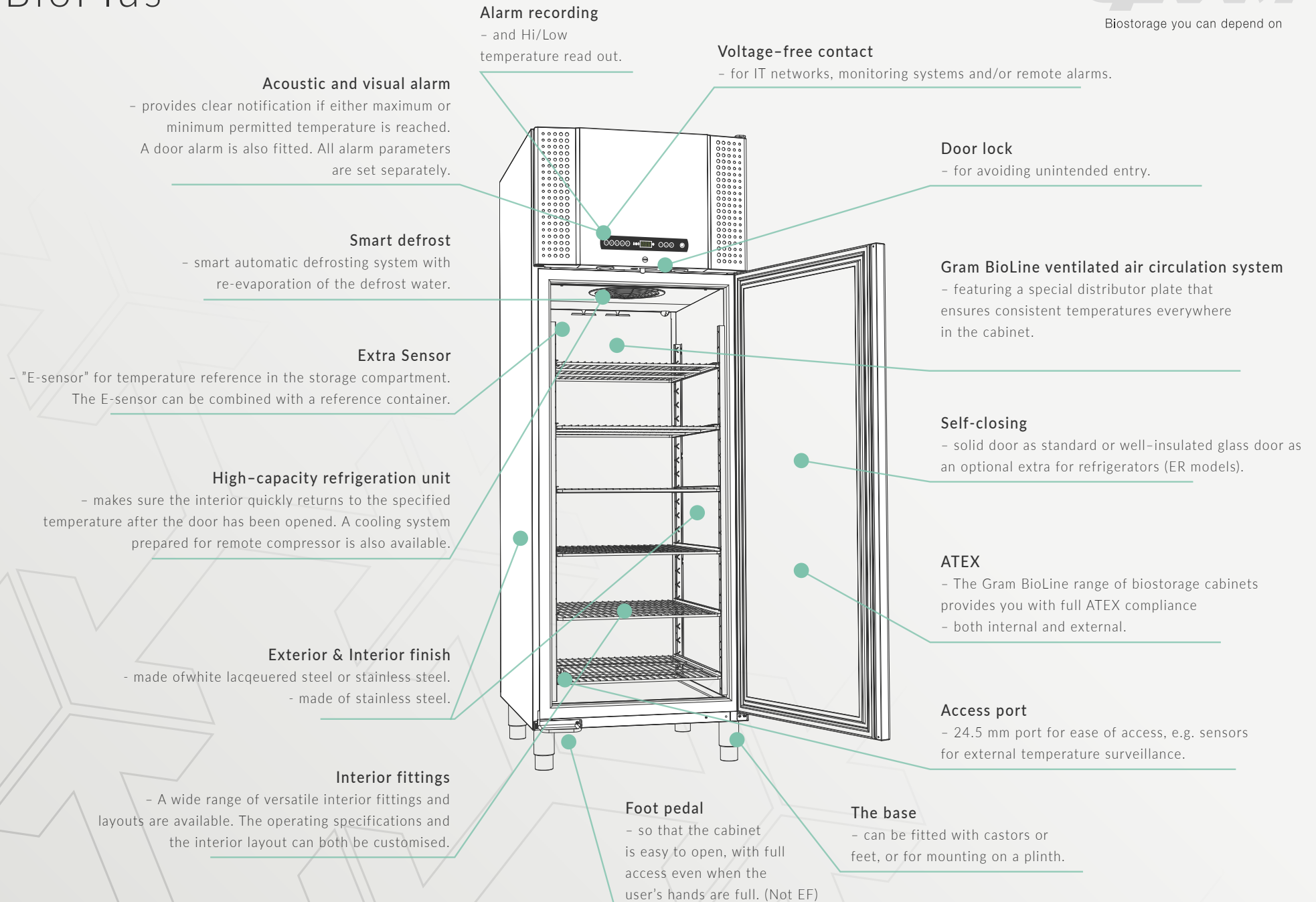





The BioPlus range is designed for the storage of the most delicate biomaterials, in situations where even tiny fluctuations in conditions inside the storage cabinet can have a serious effect on the contents. BioPlus refrigerators also enable you to reduce internal relative humidity, thus cutting down on any likelihood of undesirable contaminants getting near delicate biomaterials. In terms of performance, these units are designed to provide the very best results even under exceptional conditions.

Available with capacities of 500, 600, 660, 930, 1270 and 1400 litres and in a range of different sizes, in either white or stainless steel finish.

BioPlus refrigerators		
ER	Extended refrigeration	-2/+20°C
BioPlus freezers		
RF	Regular freezer	-25/-5°C
EF	Extended freezer	-35/-5°C

- ① The Gram MPC 4.6 lets you adjust several different parameters individually, so that you can adjust the cabinet's operating profile to specific requirements or changing needs.
- ② Glass door (optional on all refrigerators) makes it easy to carry out rapid, at-a-glance checks of the contents of the cabinet.
- ③ The interior is made of stainless steel that is extremely durable, ready to withstand many years of use. Access port located in the back of the cabinet.



# BioPlus ER500



**Ex II 3G Ex nA nC nL IIB T2 Gc**

Price (white)  
**€ 4,690**

Price (stainless steel)  
**€ 4,940**

Technical specifications	
Temperature range	-2/+20°C
Ambient temperature range	Solid door +10/+43°C; glass door +10/+38°C
Control Unit	Gram Control Unit with voltage-free contact, E-sensor, acoustic and visual door and temperature alarms that can be programmed individually, alarm recording, dry cool function and offset function
Material: Interior	Stainless steel
Exterior	White lacquered steel or stainless steel
Ext. dimensions mm (W x D x H):	600 x 805 x 2025/2275
Net weight	Unpackaged net weight without optional fittings: 130 kg
Gross volume	500 litres/17.7 cubic feet
Net volume	365 litres/12.9 cubic feet
Modules for shelves and drawers	52 (see page 76)
Insulation	60 mm polyurethane with HFC-free cyclopentane propellant
K-Value	Solid door 0.3149 W/m <sup>2</sup> K; glass door 0.4641 W/m <sup>2</sup> K
Refrigerant	R290/ R134a <sup>***</sup> /prepared for external compressor
CO <sub>2</sub> e	R134a: 372
Refrigeration capacity at -10°C	R290 389 watt; R134a 314 watt
Energy consumption	1.26 kWh/24h (see page 72)
Connection	230 V, 50 Hz
Sound level	46.2 dB(A)
Air system	Gram BioLine ventilated air distribution system
Defrost system	Automatic smart defrost with re-evaporation of the defrost water

## Optional fittings and equipment – product configuration guide on page 12

A	BioLine aluminium drawer with length and cross dividers	€ 165	11	Glass door	€ 230	81	Low-temperature protection	€ 135
R	BioLine stainless steel drawer 30 kg	€ 165	70	Draught shields (set of 3 inner doors)*	€ 385	82	60 Hz compressor	€ 0
S	BioLine stainless steel drawer 40 kg	€ 220	50	Chart recorder	€ 650	V	Reference container	€ 30
C	BioLine dividers for stainless steel drawers (1 set)	€ 60	69	DIN kit 58345	€ 165		**Legs, wheels or for mounting on a plinth	€ 0
P	BioLine perforated shelf in stainless steel	€ 80				31	Castors, 360°C swivel	€ 40
T	BioLine wire shelf in stainless steel	€ 55				20/21	Door hinge – on right or left side	€ 0
N	BioLine wire shelf with plastic coating	€ 40						

\* Cannot be combined with BioLine wire shelf with plastic coating or aluminium drawers

\*\* See page 79

\*\*\* R134a available outside European Union

Option codes

# BioPlus RF500 ❄️ -25 °C



**Ex II 3G Ex nA nC nL IIB T2 Gc**

Price (white)  
**€ 5,240**

Price (stainless steel)  
**€ 5,490**

Technical specifications	
Temperature range	-25/-5°C
Ambient temperature range	+10/+43°C
Control Unit	Gram Control Unit with voltage-free contact, E-sensor, acoustic and visual door and temperature alarms that can be programmed individually, alarm recording and offset function
Material: Interior	Stainless steel
Exterior	White lacquered steel or stainless steel
Ext. dimensions mm (W x D x H):	600 x 805 x 2025/2275
Net weight	Unpackaged net weight without optional fittings: 130 kg
Gross volume	500 litres/17.7 cubic feet
Net volume	365 litres/12.9 cubic feet
Modules for shelves and drawers	52 (see page 76)
Insulation	60 mm polyurethane with HFC-free cyclopentane propellant
K-Value	Solid door 0.3149W/m²K
Refrigerant	R290/R404A***/prepared for external compressor
CO <sub>2</sub> e	R404A: 981
Refrigeration capacity at -25°C	R290 374 watt; R404A 568 watt
Energy consumption	3.83 kWh/24h (see page 73)
Connection	230 V, 50 Hz
Sound level	48.7 dB(A)
Air system	Gram BioLine ventilated air distribution system
Defrost system	Automatic smart defrost with re-evaporation of the defrost water

## Optional fittings and equipment – product configuration guide on page 12

R	BioLine stainless steel drawer 30 kg	€ 165	70	Draught shields (set of 3 inner doors)*	€ 385	V	Reference container	€ 30
S	BioLine stainless steel drawer 40 kg	€ 220	50	Chart recorder	€ 650		** Legs, wheels or for mounting on a plinth	€ 0
C	BioLine dividers for stainless steel drawers (1 set)	€ 60	82	60 Hz compressor	€ 0	31	Castors, 360° swivel	€ 40
P	BioLine perforated shelf in stainless steel	€ 80				20/21	Door hinge – on right or left side	€ 0
T	BioLine wire shelf in stainless steel	€ 55						
N	BioLine wire shelf with plastic coating	€ 40						

\* Cannot be combined with Bioline wire shelf with plastic coating

\*\* See page 79

\*\*\* R404A Available outside European Union

Option codes

# BioPlus ER600D



**II 3G Ex nA nC nL IIB T2 Gc**

Price (white)  
**€ 4,840**

Price (stainless steel)  
**€ 5,090**

## Technical specifications

Temperature range	-2/+20°C
Ambient temperature range	Solid door +10/+43°C; glass door 10/38°C
Control Unit	Gram Control Unit with voltage-free contact, E-sensor, acoustic and visual door and temperature alarms that can be programmed individually, alarm recording, dry cool function and offset function
Material: Interior	Stainless steel
Exterior	White lacquered steel or stainless steel
Ext. dimensions mm (W x D x H):	695 x 876 x 1875/2125
Net weight	Unpackaged net weight without optional fittings: 146 kg
Gross volume	600 litres/21.2 cubic feet
Net volume	432 litres/15.3 cubic feet
Modules for shelves and drawers	24 (see page 76)
Insulation	60 mm polyurethane with HFC-free cyclopentane propellant
K-Value	Solid door 0.3139 W/m <sup>2</sup> K; glass door 0.4634 W/m <sup>2</sup> K
Refrigerant	R290/ R134a <sup>***</sup> /prepared for external compressor
CO <sub>2</sub> e	R134a: 329
Refrigeration capacity at -10°C	R290 389 watt; R134a 314 watt
Energy consumption	1.26 kWh/24h (see page 72)
Connection	230 V, 50 Hz
Sound level	46 dB(A)
Air system	Gram BioLine ventilated air distribution system
Defrost system	Automatic smart defrost with re-evaporation of the defrost water

## Optional fittings and equipment – product configuration guide on page 12

A	BioLine aluminium drawer with length and cross dividers	€ 165	11	Glass door	€ 230	V	Reference container	€ 30
R	BioLine stainless steel drawer 30 kg	€ 165	70	Draught shields (set of 3 inner doors)*	€ 385		** Legs, wheels or for mounting on a plinth	€ 0
S	BioLine stainless steel drawer 40 kg	€ 220	50	Chart recorder	€ 650	31	Castors, 360° swivel	€ 40
C	BioLine dividers for stainless steel drawers (1 set)	€ 60	81	Low-temperature protection	€ 135	20/21	Door hinge – on right or left side	€ 0
P	BioLine perforated shelf in stainless steel	€ 80	82	60 Hz compressor	€ 0			
T	BioLine wire shelf in stainless steel	€ 55	69	DIN kit 58345	€ 165			
N	BioLine wire shelf with plastic coating	€ 40						

\* Cannot be combined with BioLine wire shelf with plastic coating

\*\* See page 79

\*\*\* R134a available outside European Union

Option codes

# BioPlus RF600D -25 °C



 II 3G Ex nA nC nL IIB T2 Gc

Price (white)  
€ 5,390

Price (stainless steel)  
€ 5,640

Technical specifications	
Temperature range	-25/-5°C
Ambient temperature range	+10/+43°C
Control Unit	Gram Control Unit with voltage-free contact, E-sensor, acoustic and visual door and temperature alarms that can be programmed individually, alarm recording and offset function
Material: Interior	Stainless steel
Exterior	White lacquered steel or stainless steel
Ext. dimensions mm (W x D x H):	695 x 876 x 1875/2125
Net weight	Unpackaged net weight without optional fittings: 146 kg
Gross volume	600 litres/21.2 cubic feet
Net volume	432 litres/15.3 cubic feet
Modules for shelves and drawers	24 (see page 76)
Insulation	60 mm polyurethane with HFC-free cyclopentane propellant
K-Value	Solid door 0.3139 W/m²K
Refrigerant	R290/ R404A***/prepared for external compressor
CO <sub>2</sub> e	R404A: 902
Refrigeration capacity at -25°C	R290 512 watt; R404A 568 watt
Energy consumption	4.03 kWh/24h (see page 73)
Connection	230 V, 50 Hz
Sound level	47.3 dB(A)
Air system	Gram BioLine ventilated air distribution system
Defrost system	Automatic smart defrost with re-evaporation of the defrost water

## Optional fittings and equipment – product configuration guide on page 12

R	BioLine stainless steel drawer 30 kg	€ 165	70	Draught shields (set of 3 inner doors)*	€ 385		** Legs, wheels or for mounting on a plinth	€ 0
S	BioLine stainless steel drawer 40 kg	€ 220	50	Chart recorder	€ 650	31	Castors, 360° swivel	€ 40
C	BioLine dividers for stainless steel drawers (1 set)	€ 60	82	60 Hz compressor	€ 0	20/21	Door hinge – on right or left side	€ 0
P	BioLine perforated shelf in stainless steel	€ 80	V	Reference container	€ 30			
T	BioLine wire shelf in stainless steel	€ 55						
N	BioLine wire shelf with plastic coating	€ 40						

\* Cannot be combined with Bioline wire shelf with plastic coating

\*\* See page 79

\*\*\* R404A Available outside European Union

 Option codes

# BioPlus ER600W

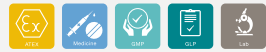

**Ex II 3G Ex nA nC nL IIB T2 Gc**

Price (white)  
**€ 4,840**

Price (stainless steel)  
**€ 5,090**

Technical specifications	
Temperature range	-2/+20°C
Ambient temperature range	Solid door +10/+43°C; glass door +10/+38°C
Control Unit	Gram Control Unit with voltage-free contact, E-sensor, acoustic and visual door and temperature alarms that can be programmed individually, alarm recording, dry cool function and offset function
Material: Interior	Stainless steel
Exterior	White lacquered steel or stainless steel
Ext. dimensions mm (W x D x H):	815 x 756 x 1875/2125
Net weight	Unpackaged net weight without optional fittings: 146 kg
Gross volume	600 litres/21.2 cubic feet
Net volume	432 litres/15.3 cubic feet
Modules for shelves and drawers	24 (see page 76)
Insulation	60 mm polyurethane with HFC-free cyclopentane propellant
K-Value	Solid door 0.3122 W/m²K; glass door 0.4904 W/m²K
Refrigerant	R290/ R134a <sup>***</sup> /prepared for external compressor
CO <sub>2</sub> e	R134a: 329 / R134a (dual comp.): 615
Refrigeration capacity at -10°C	R290 389 watt; R134a 314 watt
Energy consumption	1.35 kWh/24h (see page 72)
Connection	230 V, 50 Hz
Sound level	44.8 dB(A)
Air system	Gram BioLine ventilated air distribution system
Defrost system	Automatic smart defrost with re-evaporation of the defrost water

## Optional fittings and equipment – product configuration guide on page 12

A	BioLine aluminium drawer with length and cross dividers	€ 165	11	Glass door	€ 230	V	Reference container	€ 30
R	BioLine stainless steel drawer 30 kg	€ 165	70	Draught shields (set of 3 inner doors)*	€ 385		** Legs, wheels or for mounting on a plinth	€ 0
S	BioLine stainless steel drawer 40 kg	€ 220	50	Chart recorder	€ 650	31	Castors, 360° swivel	€ 40
C	BioLine dividers for stainless steel drawers (1 set)	€ 60	81	Low-temperature protection	€ 135	20/21	Door hinge – on right or left side	€ 0
P	BioLine perforated shelf in stainless steel	€ 80	82	60 Hz compressor	€ 0	80	Dual refrigeration circuit	€ 650
T	BioLine wire shelf in stainless steel	€ 55	69	DIN kit 58345	€ 165			
N	BioLine wire shelf with plastic coating	€ 40						

\* Cannot be combined with BioLine wire shelf with plastic coating

\*\* See page 80

\*\*\* R134a available outside European Union

Option codes

# BioPlus RF600W -25 °C



 II 3G Ex nA nC nL IIB T2 Gc

Price (white)  
€ 5,390

Price (stainless steel)  
€ 5,640

Technical specifications	
Temperature range	-25/-5°C
Ambient temperature range	+10/+43°C
Control Unit	Gram Control Unit with voltage-free contact, E-sensor, acoustic and visual door and temperature alarms that can be programmed individually, alarm recording and offset function
Material: Interior	Stainless steel
Exterior	White lacquered steel or stainless steel
Ext. dimensions mm (W x D x H):	815 x 756 x 1875/2125
Net weight	Unpackaged net weight without optional fittings: 146 kg
Gross volume	600 litres/21.2 cubic feet
Net volume	432 litres/15.3 cubic feet
Modules for shelves and drawers	24 (see page 76)
Insulation	60 mm polyurethane with HFC-free cyclopentane propellant
K-Value	Solid door 0.3122 W/m²K
Refrigerant	R290/ R404A***/prepared for external compressor
CO <sub>2</sub> e	R404A: 902/ R404A (dual comp.): 1545
Refrigeration capacity at -25°C	R 290 512 watt; R404A 616 watt
Energy consumption	4.07 kWh/24h (see page 73)
Connection	230 V, 50 Hz
Sound level	45.8 dB(A)
Air system	Gram BioLine ventilated air distribution system
Defrost system	Automatic smart defrost with re-evaporation of the defrost water

## Optional fittings and equipment – product configuration guide on page 12

R	BioLine stainless steel drawer 30 kg	€ 165	70	Draught shields (set of 3 inner doors)*	€ 385		** Legs, wheels or for mounting on a plinth	€ 0
S	BioLine stainless steel drawer 40 kg	€ 220	50	Chart recorder	€ 650	31	Castors, 360° swivel	€ 40
C	BioLine dividers for stainless steel drawers (1 set)	€ 60	82	60 Hz compressor	€ 0	20/21	Door hinge – on right or left side	€ 0
P	BioLine perforated shelf in stainless steel	€ 80	V	Reference container	€ 30	80	Dual refrigeration circuit	€ 650
T	BioLine wire shelf in stainless steel	€ 55						
N	BioLine wire shelf with plastic coating	€ 40						

\* Cannot be combined with Bioline wire shelf with plastic coating

\*\* See page 80

\*\*\* R404A Available outside European Union

 Option codes

# BioPlus ER660D



**Ex II 3G Ex nA nC nL IIB T2 Gc**

Price (white)  
**€ 4,990**

Price (stainless steel)  
**€ 5,240**

## Technical specifications

Temperature range	-2/+20°C
Ambient temperature range	Solid door +10/+43°C; glass door +10/+38°C
Control Unit	Gram Control Unit with voltage-free contact, E-sensor, acoustic and visual door and temperature alarms that can be programmed individually, alarm recording, dry cool function and offset function
Material: Interior	Stainless steel
Exterior	White lacquered steel or stainless steel
Ext. dimensions mm (W x D x H):	695 x 876 x 2025/2275
Net weight	Unpackaged net weight without optional fittings: 152 kg
Gross volume	660 litres/23.3 cubic feet
Net volume	484 litres/17.0 cubic feet
Modules for shelves and drawers	27 (see page 76)
Insulation	60 mm polyurethane with HFC-free cyclopentane propellant
K-Value	Solid door 0.3138 W/m <sup>2</sup> K; glass door 0.458 W/m <sup>2</sup> K
Refrigerant	R290/ R134a <sup>***</sup> /prepared for external compressor
CO <sub>2</sub> e	R134a: 329
Refrigeration capacity at -10°C	R290 389 watt; R134a 314 watt
Energy consumption	1.18 kWh/24h (see page 72)
Connection	230 V, 50 Hz
Sound level	45.9 dB(A)
Air system	Gram BioLine ventilated air distribution system
Defrost system	Automatic smart defrost with re-evaporation of the defrost water

## Optional fittings and equipment – product configuration guide on page 12

A	BioLine aluminium drawer with length and cross dividers	€ 165	11	Glass door	€ 230	V	Reference container	€ 30
R	BioLine stainless steel drawer 30 kg	€ 165	70	Draught shields (set of 3 inner doors)*	€ 385		** Legs, wheels or for mounting on a plinth	€ 0
S	BioLine stainless steel drawer 40 kg	€ 220	50	Chart recorder	€ 650	31	Castors, 360° swivel	€ 40
C	BioLine dividers for stainless steel drawers (1 set)	€ 60	81	Low-temperature protection	€ 135	20/21	Door hinge – on right or left side	€ 0
P	BioLine perforated shelf in stainless steel	€ 80	82	60 Hz compressor	€ 0			
T	BioLine wire shelf in stainless steel	€ 55	69	DIN kit 58345	€ 165			
N	BioLine wire shelf with plastic coating	€ 40						

\* Cannot be combined with Bioline wire shelf with plastic coating

\*\* See page 79

\*\*\* R134a available outside European Union

Option codes



# BioPlus RF660D -25 °C



 II 3G Ex nA nC nL IIB T2 Gc

Price (white)  
€ 5,540

Price (stainless steel)  
€ 5,790

Technical specifications	
Temperature range	-25/-5°C
Ambient temperature range	+10/+43°C
Control Unit	Gram Control Unit with voltage-free contact, E-sensor, acoustic and visual door and temperature alarms that can be programmed individually, alarm recording and offset function
Material: Interior	Stainless steel
Exterior	White lacquered steel or stainless steel
Ext. dimensions mm (W x D x H):	695 x 876 x 2025/2275
Net weight	Unpackaged net weight without optional fittings: 152 kg
Gross volume	660 litres/23.3 cubic feet
Net volume	484 litres/17.0 cubic feet
Modules for shelves and drawers	27 (see page 76)
Insulation	60 mm polyurethane with HFC-free cyclopentane propellant
K-Value	Solid door 0.3138 W/m²K
Refrigerant	R290/ R404A***/prepared for external compressor
CO <sub>2</sub> e	R404A: 902
Refrigeration capacity at -25°C	R 290 512 watt; R404A 616 watt
Energy consumption	4.23 kWh/24h (see page 73)
Connection	230 V, 50 Hz
Sound level	45.6 dB(A)
Air system	Gram BioLine ventilated air distribution system
Defrost system	Automatic smart defrost with re-evaporation of the defrost water

## Optional fittings and equipment – product configuration guide on page 12

R	BioLine stainless steel drawer 30 kg	€ 165	70	Draught shields (set of 3 inner doors)*	€ 385		** Legs, wheels or for mounting on a plinth	€ 0
S	BioLine stainless steel drawer 40 kg	€ 220	50	Chart recorder	€ 650	31	Castors, 360° swivel	€ 40
C	BioLine dividers for stainless steel drawers (1 set)	€ 60	82	60 Hz compressor	€ 0	20/21	Door hinge – on right or left side	€ 0
P	BioLine perforated shelf in stainless steel	€ 80	V	Reference container	€ 30			
T	BioLine wire shelf in stainless steel	€ 55						
N	BioLine wire shelf with plastic coating	€ 40						

\* Cannot be combined with Bioline wire shelf with plastic coating

\*\* See page 79

\*\*\* R404A Available outside European Union

 Option codes

# BioPlus ER660W



**Ex II 3G Ex nA nC nL IIB T2 Gc**

Price (white)  
**€ 4,990**

Price (stainless steel)  
**€ 5,240**

Technical specifications	
Temperature range	-2/+20°C
Ambient temperature range	Solid door +10/+43°C; glass door +10/+38°C
Control Unit	Gram Control Unit with voltage-free contact, E-sensor, acoustic and visual door and temperature alarms that can be programmed individually, alarm recording, dry cool function and offset function
Material: Interior Exterior	Stainless steel White lacquered steel or stainless steel
Ext. dimensions mm (W x D x H):	815 x 756 x 2025/2275
Net weight	Unpackaged net weight without optional fittings: 152 kg
Gross volume	660 litres/23.3 cubic feet
Net volume	484 litres/17.0 cubic feet
Modules for shelves and drawers	27 (see page 76)
Insulation	60 mm polyurethane with HFC-free cyclopentane propellant
K-Value	Solid door 0.3121 W/m²K; glass door 0.4933W/m²K
Refrigerant	R290/ R134a**/prepared for external compressor
CO <sub>2</sub> e	R134a: 329 / R134a (dual comp.): 615
Refrigeration capacity at -10°C	R290 389 watt; R134a 314 watt
Energy consumption	1.28 kWh/24h (see page 72)
Connection	230 V, 50 Hz
Sound level	44.8 dB(A)
Air system	Gram BioLine ventilated air distribution system
Defrost system	Automatic smart defrost with re-evaporation of the defrost water

## Optional fittings and equipment – product configuration guide on page 12

A	BioLine aluminium drawer with length and cross dividers	€ 165	11	Glass door	€ 230	V	Reference container	€ 30
R	BioLine stainless steel drawer 30 kg	€ 165	70	Draught shields (set of 3 inner doors)*	€ 385		** Legs, wheels or for mounting on a plinth	€ 0
S	BioLine stainless steel drawer 40 kg	€ 220	50	Chart recorder	€ 650	31	Castors, 360° swivel	€ 40
C	BioLine dividers for stainless steel drawers (1 set)	€ 60	81	Low-temperature protection	€ 135	20/21	Door hinge – on right or left side	€ 0
P	BioLine perforated shelf in stainless steel	€ 80	82	60 Hz compressor	€ 0	80	Dual refrigeration circuit	€ 650
T	BioLine wire shelf in stainless steel	€ 55	69	DIN kit 58345	€ 165			
N	BioLine wire shelf with plastic coating	€ 40						

\* Cannot be combined with BioLine wire shelf with plastic coating

\*\* See page 80

\*\*\* R134a available outside European Union

Option codes

# BioPlus RF660W -25 °C

bioline



 II 3G Ex nA nC nL IIB T2 Gc

Price (white)  
€ 5,540

Price (stainless steel)  
€ 5,790

## Technical specifications

Temperature range	-25/-5°C
Ambient temperature range	+10/+43°C
Control Unit	Gram Control Unit with voltage-free contact, E-sensor, acoustic and visual door and temperature alarms that can be programmed individually, alarm recording and offset function
Material: Interior	Stainless steel
Exterior	White lacquered steel or stainless steel
Ext. dimensions mm (W x D x H):	815 x 756 x 2025/2275
Net weight	Unpackaged net weight without optional fittings: 152 kg
Gross volume	660 litres/23.3 cubic feet
Net volume	484 litres/17.0 cubic feet
Modules for shelves and drawers	27 (see page 76)
Insulation	60 mm polyurethane with HFC-free cyclopentane propellant
K-Value	Solid door 0.3121 W/m²K
Refrigerant	R290/ R404A***/prepared for external compressor
CO <sub>2</sub> e	R404A: 902/ R404A(dual comp): 1545
Refrigeration capacity at -25°C	R290 512 watt ; R404A 616 watt
Energy consumption	4.46 kWh/24h (see page 73)
Connection	230 V, 50 Hz
Sound level	49.3 dB(A)
Air system	Gram BioLine ventilated air distribution system
Defrost system	Automatic smart defrost with re-evaporation of the defrost water

## Optional fittings and equipment – product configuration guide on page 12

R	BioLine stainless steel drawer 30 kg	€ 165	70	Draught shields (set of 3 inner doors)*	€ 385		** Legs, wheels or for mounting on a plinth	€ 0
S	BioLine stainless steel drawer 40 kg	€ 220	50	Chart recorder	€ 650	31	Castors, 360° swivel	€ 40
C	BioLine dividers for stainless steel drawers (1 set)	€ 60	82	60 Hz compressor	€ 0	20/21	Door hinge – on right or left side	€ 0
P	BioLine perforated shelf in stainless steel	€ 80	V	Reference container	€ 30	80	Dual refrigeration circuit	€ 650
T	BioLine wire shelf in stainless steel	€ 55						
N	BioLine wire shelf with plastic coating	€ 40						

\* Cannot be combined with Bioline wire shelf with plastic coating

\*\* See page 80

\*\*\* R404A Available outside European Union

 Option codes

# BioPlus ER930



**Ex II 3G Ex nA nC nL IIB T2 Gc**

Price (white)  
**€ 5,440**

Price (stainless steel)  
**€ 5,690**

## Technical specifications

Temperature range	-2/+20°C
Ambient temperature range	Solid door +10/+43°C; glass door +10/+38°C
Control Unit	Gram Control Unit with voltage-free contact, E-sensor, acoustic and visual door and temperature alarms that can be programmed individually, alarm recording, dry cool function and offset function
Material: Interior	Stainless steel
Exterior	White lacquered steel or stainless steel
Ext. dimensions mm (W x D x H):	780 x 1045 x 2025/2275
Net weight	Unpackaged net weight without optional fittings: 165 kg
Gross volume	930 litres/32.8 cubic feet
Net volume	702 litres/24.8 cubic feet
Modules for shelves and drawers	52 (see page 76)
Insulation	60 mm polyurethane with HFC-free cyclopentane propellant
K-Value	Solid door 0.3137 W/m²K; glass door 0.4563 W/m²K
Refrigerant	R290/ R134a <sup>***</sup> /prepared for external compressor
CO <sub>2</sub> e	R134a: 572
Refrigeration capacity at -10°C	R290 627 watt / R134a 487 watt
Energy consumption	2.10 kWh/24h (see page 72)
Connection	230 V, 50 Hz
Sound level	48.5 dB(A)
Air system	Gram BioLine ventilated air distribution system
Defrost system	Automatic smart defrost with re-evaporation of the defrost water

## Optional fittings and equipment – product configuration guide on page 12

S	BioLine stainless steel drawer 40 kg	€ 220	11	Glass door	€ 230	V	Reference container	€ 30
P	BioLine perforated shelf in stainless steel	€ 80	50	Chart recorder	€ 650		** Legs, wheels or for mounting on a plinth	€ 0
T	BioLine wire shelf in stainless steel	€ 55	69	DIN kit 58345	€ 165	31	Castors, 360° swivel	€ 40
C	BioLine dividers for stainless steel drawers (1 set)	€ 60	81	Low-temperature protection	€ 135	20/21	Door hinge – on right or left side	€ 0
			82	60 Hz compressor	€ 0			

\*\* See page 80

\*\*\* R134a available outside European Union

Option codes

# BioPlus RF930 ❄️ -25 °C



**Ex II 3G Ex nA nC nL IIB T2 Gc**

Price (white)  
**€ 5,990**

Price (stainless steel)  
**€ 6,240**

Technical specifications	
Temperature range	-25/-5°C
Ambient temperature range	+10/+43°C
Control Unit	Gram Control Unit with voltage-free contact, E-sensor, acoustic and visual door and temperature alarms that can be programmed individually, alarm recording and offset function
Material: Interior	Stainless steel
Exterior	White lacquered steel or stainless steel
Ext. dimensions mm (W x D x H):	780 x 1045 x 2025/2275
Net weight	Unpackaged net weight without optional fittings: 165 kg
Gross volume	930 litres/32.8 cubic feet
Net volume	702 litres/24.8 cubic feet
Modules for shelves and drawers	52 (see page 76)
Insulation	60 mm polyurethane with HFC-free cyclopentane propellant
K-Value	Solid door 0.3137 W/m²K
Refrigerant	R290/R404A***/prepared for external compressor
CO <sub>2</sub> e	R404A: 1177
Refrigeration capacity at -25°C	R290 931 watt; R404A 714 watt
Energy consumption	6.12 kWh/24h (see page 73)
Connection	230 V, 50 Hz
Sound level	49.5 dB(A)
Air system	Gram BioLine ventilated air distribution system
Defrost system	Automatic smart defrost with re-evaporation of the defrost water

## Optional fittings and equipment – product configuration guide on page 12

S	BioLine stainless steel drawer 40 kg	€ 220	50	Chart recorder	€ 650		** Legs, wheels or for mounting on a plinth	€ 0
P	BioLine perforated shelf in stainless steel	€ 80	82	60 Hz compressor	€ 0	31	Castors, 360° swivel	€ 40
T	BioLine wire shelf in stainless steel	€ 55	V	Reference container	€ 30	20/21	Door hinge – on right or left side	€ 0
C	BioLine dividers for stainless steel drawers (1 set)	€ 60						

\*\* See page 80

\*\*\* R404A Available outside European Union

Option codes

# BioPlus ER1270



**Ex II 3G Ex nA nC nL IIB T3 Gc**

Price (white)  
**€ 6,790**

Price (stainless steel)  
**€ 7,240**

Technical specifications	
Temperature range	-2/+20°C
Ambient temperature range	Solid door +10/+43°C; glass door +10/+38°C
Control Unit	Gram Control Unit with voltage-free contact, E-sensor, acoustic and visual door and temperature alarms that can be programmed individually, alarm recording, dry cool function and offset function
Material: Interior	Stainless steel
Exterior	White lacquered steel or stainless steel
Ext. dimensions mm (W x D x H):	1390 x 876 x 1875/2125
Net weight	Unpackaged net weight without optional fittings: 271 kg
Gross volume	1270 litres/44.8 cubic feet
Net volume	864 litres/30.6 cubic feet
Modules for shelves and drawers	48 (see page 76)
Insulation	60 mm polyurethane with HFC-free cyclopentane propellant
K-Value	Solid door 0.3125 W/m²K; glass door 0.5040 W/m²K
Refrigerant	R290/ R134a <sup>***</sup> /prepared for external compressor
CO <sub>2</sub> e	R134a: 508 / R134a (dual comp.): 615
Refrigeration capacity at -10°C	R290 946 watt; R134a 703 watt
Energy consumption	2.50 kWh/24h (see page 72)
Connection	230 V, 50 Hz
Sound level	48.3 dB(A)
Air system	Gram BioLine ventilated air distribution system
Defrost system	Automatic smart defrost with re-evaporation of the defrost water

## Optional fittings and equipment – product configuration guide on page 12

A	BioLine aluminium drawer with length and cross dividers	€ 165	11	Glass doors	€ 460	81	Low-temperature protection	€ 135
R	BioLine stainless steel drawer 30 kg	€ 165	70	Draught shields (set of 6 inner doors)*	€ 770	82	60 Hz compressor	€ 0
S	BioLine stainless steel drawer 40 kg	€ 220	50	Chart recorder	€ 650	V	Reference container	€ 30
C	BioLine dividers for stainless steel drawers (1 set)	€ 60	69	DIN kit 58345	€ 165		** Legs, wheels or for mounting on a plinth	€ 0
P	BioLine perforated shelf in stainless steel	€ 80				31	Castors, 360° swivel	€ 0
T	BioLine wire shelf in stainless steel	€ 55				80	Dual refrigeration circuit	€ 650
N	BioLine wire shelf with plastic coating	€ 40						

\* Cannot be combined with BioLine wire shelf with plastic coating

\*\* See page 81

\*\*\* R134a available outside European Union

Option codes

# BioPlus RF1270 ❄️ -25 °C



**Ex II 3G Ex nA nC nL IIB T3 Gc**

Price (white)  
**€ 7,340**

Price (stainless steel)  
**€ 7,790**

Technical specifications	
Temperature range	-25/-5°C
Ambient temperature range	+10/+43°C
Control Unit	Gram Control Unit with voltage-free contact, E-sensor, acoustic and visual door and temperature alarms that can be programmed individually, alarm recording and offset function
Material: Interior	Stainless steel
Exterior	White lacquered steel or stainless steel
Ext. dimensions mm (W x D x H):	1390 x 876 x 1875/2125
Net weight	Unpackaged net weight without optional fittings: 271 kg
Gross volume	1270 litres/44.8 cubic feet
Net volume	864 litres/30.6 cubic feet
Modules for shelves and drawers	48 (see page 76)
Insulation	60 mm polyurethane with HFC-free cyclopentane propellant
K-Value	Solid door 0.3125 W/m²K
Refrigerant	R290/R404A***/prepared for external compressor
CO <sub>2</sub> e	R404A: 1647 / R404A (dual comp.) 1726
Refrigeration capacity at -25°C	R290 950 watt; R404A 947 watt
Energy consumption	7.97 kWh/24h (see page 73)
Connection	230 V, 50 Hz
Sound level	51 dB(A)
Air system	Gram BioLine ventilated air distribution system
Defrost system	Automatic smart defrost with re-evaporation of the defrost water

## Optional fittings and equipment – product configuration guide on page 12

R	BioLine stainless steel drawer 30 kg	€ 165	70	Draught shields (set of 6 inner doors)*	€ 770	V	Reference container	€ 30
S	BioLine stainless steel drawer 40 kg	€ 220	50	Chart recorder	€ 650		** Legs, wheels or for mounting on a plinth	€ 0
C	BioLine dividers for stainless steel drawers (1 set)	€ 60	82	60 Hz compressor	€ 0	31	Castors, 360° swivel	€ 0
P	BioLine perforated shelf in stainless steel	€ 80				80	Dual refrigeration circuit	€ 650
T	BioLine wire shelf in stainless steel	€ 55						
N	BioLine wire shelf with plastic coating	€ 40						

\* Cannot be combined with Bioline wire shelf with plastic coating

\*\* See page 81

\*\*\*R404A Available outside European Union

Option codes

# BioPlus ER1400



**Ex II 3G Ex nA nC nL IIB T3 Gc**

Price (white)  
**€ 6,990**

Price (stainless steel)  
**€ 7,440**

Technical specifications	
Temperature range	-2/+20°C
Ambient temperature range	Solid door +10/+43°C; glass door +10/+38°C
Control Unit	Gram Control Unit with voltage-free contact, E-sensor, acoustic and visual door and temperature alarms that can be programmed individually, alarm recording, dry cool function and offset function
Material: Interior	Stainless steel
Exterior	White lacquered steel or stainless steel
Ext. dimensions mm (W x D x H):	1390 x 876 x 2025/2275
Net weight	Unpackaged net weight without optional fittings: 283 kg
Gross volume	1400 litres/49.4 cubic feet
Net volume	968 litres/34.0 cubic feet
Modules for shelves and drawers	54 (see page 76)
Insulation	60 mm polyurethane with HFC-free cyclopentane propellant
K-Value	Solid door 0.3124 W/m²K; glass door 0.5081 W/m²K
Refrigerant	R290/ R134a***/prepared for external compressor
CO <sub>2</sub> e	R134a: 508 / R134a (dual comp.): 615
Refrigeration capacity at -10°C	R290 946 watt; R134a 703 watt
Energy consumption	2.56 kWh/24h (see page 72)
Connection	230 V, 50 Hz
Sound level	47.5 dB(A)
Air system	Gram BioLine ventilated air distribution system
Defrost system	Automatic smart defrost with re-evaporation of the defrost water

## Optional fittings and equipment – product configuration guide on page 12

A	BioLine aluminium drawer with length and cross dividers	€ 165	11	Glass doors	€ 460	V	Reference container	€ 30
R	BioLine stainless steel drawer 30 kg	€ 165	70	Draught shields (set of 6 inner doors)*	€ 770		** Legs, wheels or for mounting on a plinth	€ 0
S	BioLine stainless steel drawer 40 kg	€ 220	50	Chart recorder	€ 650	31	Castors, 360° swivel	€ 0
C	BioLine dividers for stainless steel drawers (1 set)	€ 60	81	Low-temperature protection	€ 135	80	Dual refrigeration circuit	€ 650
P	BioLine perforated shelf in stainless steel	€ 80	82	60 Hz compressor	€ 0			
T	BioLine wire shelf in stainless steel	€ 55	69	DIN kit 58345	€ 165			
N	BioLine wire shelf with plastic coating	€ 40						

\* Cannot be combined with Bioline wire shelf with plastic coating

\*\* See page 81

\*\*\* R134a available outside European Union

Option codes



# BioPlus RF1400 ❄️ -25 °C



**Ex II 3G Ex nA nC nL IIB T3 Gc**

Price (white)  
**€ 7,540**

Price (stainless steel)  
**€ 7,990**

Technical specifications	
Temperature range	-25/-5°C
Ambient temperature range	+10/+43°C
Control Unit	Gram Control Unit with voltage-free contact, E-sensor, acoustic and visual door and temperature alarms that can be programmed individually, alarm recording and offset function
Material: Interior	Stainless steel
Exterior	White lacquered steel or stainless steel
Ext. dimensions mm (W x D x H):	1390 x 876 x 2025/2275
Net weight	Unpackaged net weight without optional fittings: 283 kg
Gross volume	1400 litres/49.4 cubic feet
Net volume	968 litres/34.0 cubic feet
Modules for shelves and drawers	54 (see page 76)
Insulation	60 mm polyurethane with HFC-free cyclopentane propellant
K-Value	Solid door 0.3124 W/m²K
Refrigerant	R290/R404A***/prepared for external compressor
CO <sub>2</sub> e	R404A: 1647 / R404A (dual comp.) 1726
Refrigeration capacity at -25°C	R290 950 watt; R404A 947 watt
Energy consumption	8.39 kWh/24h (see page 73)
Connection	230 V, 50 Hz
Sound level	46.6 dB(A)
Air system	Gram BioLine ventilated air distribution system
Defrost system	Automatic smart defrost with re-evaporation of the defrost water

## Optional fittings and equipment – product configuration guide on page 12

R	BioLine stainless steel drawer 30 kg	€ 165	70	Draught shields (set of 6 inner doors)*	€ 770		** Legs, wheels or for mounting on a plinth	€ 0
S	BioLine stainless steel drawer 40 kg	€ 220	50	Chart recorder	€ 650	31	Castors, 360° swivel	€ 0
C	BioLine dividers for stainless steel drawers (1 set)	€ 60	82	60 Hz compressor	€ 0	80	Dual refrigeration circuit	€ 650
P	BioLine perforated shelf in stainless steel	€ 80	V	Reference container	€ 30			
T	BioLine wire shelf in stainless steel	€ 55						
N	BioLine wire shelf with plastic coating	€ 40						

\* Cannot be combined with Bioline wire shelf with plastic coating

\*\* See page 81

\*\*\* R404A Available outside European Union

Option codes

# BioPlus EF 600W -35 °C

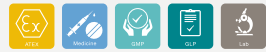

 II 3G Ex nA nC nL IIB T2 Gc

Price (white)  
€ 6,140

Price (stainless steel)  
€ 6,390

## Technical specifications

Temperature range	-35/-5°C
Ambient temperature range	+10/+30°C
Control Unit	Gram Control Unit with voltage-free contact, E-sensor, acoustic and visual door and temperature alarms that can be programmed individually, alarm recording and offset function
Material: Interior Exterior	Stainless steel and inner doors in PMMA White lacquered steel or stainless steel
Ext. dimensions mm (W x D x H):	837 x 756 x 1875/2125
Net weight	Unpackaged net weight without optional fittings: 146 kg
Gross volume	600 litres/21.2 cubic feet
Net volume	432 litres/15.3 cubic feet
Modules for shelves and drawers	24 (see page 76)
Insulation	60 mm polyurethane with HFC-free cyclopentane propellant
K-Value	Solid door 0.3122W/m²K
Refrigerant	R290/R404A***/prepared for external compressor
CO <sub>2</sub> e	R404A: 1412 / R404A (dual comp.) 1545
Refrigeration capacity at -40°C	R290 244 watt; R404A 313 watt
Energy consumption	8.86 kWh/24h (see page 73)
Connection	230 V, 50 Hz
Sound level	55.3 dB(A)
Air system	Gram BioLine ventilated air distribution system
Defrost system	Automatic smart defrost with re-evaporation of the defrost water

## Optional fittings and equipment – product configuration guide on page 12

R	BioLine stainless steel drawer 30 kg	€ 165	50	Chart recorder	€ 650		** Legs, wheels or for mounting on a plinth	€ 0
S	BioLine stainless steel drawer 40 kg	€ 220	82	60 Hz compressor	€ 0	31	Castors, 360° swivel	€ 40
C	BioLine dividers for stainless steel drawers (1 set)	€ 60	V	Reference container	€ 30	80	Dual refrigeration circuit	€ 650
P	BioLine perforated shelf in stainless steel	€ 80	20/21	Door hinge – on right or left side	€ 0			
TTT	BioLine wire shelf in stainless steel	€ 55						

\*\* See page 80

\*\*\* R404A Available outside European Union

 Option codes

# BioPlus EF 660W -35 °C

bioline



 II 3G Ex nA nC nL IIB T2 Gc

Price (white)  
€ 6,290

Price (stainless steel)  
€ 6,540

## Technical specifications

Temperature range	-35/-5°C
Ambient temperature range	+10/+30°C
Control Unit	Gram Control Unit with voltage-free contact, E-sensor, acoustic and visual door and temperature alarms that can be programmed individually, alarm recording and offset function
Material: Interior Exterior	Stainless steel and inner doors in PMMA White lacquered steel or stainless steel
Ext. dimensions mm (W x D x H):	837 x 756 x 2025/2275
Net weight	Unpackaged net weight without optional fittings: 152 kg
Gross volume	660 litres/23.3 cubic feet
Net volume	484 litres/17.0 cubic feet
Modules for shelves and drawers	27 (see page 76)
Insulation	60 mm polyurethane with HFC-free cyclopentane propellant
K-Value	Solid door 0.3131 W/m²K
Refrigerant	R290/R404A <sup>***</sup> /prepared for external compressor
CO <sub>2</sub> e	R404A: 1412 / R404A (dual comp.) 1545
Refrigeration capacity at -40°C	R290 244 watt; R404A 313 watt
Energy consumption	9.02 kWh/24h (see page 73)
Connection	230 V, 50 Hz
Sound level	55.3 dB(A)
Air system	Gram BioLine ventilated air distribution system
Defrost system	Automatic smart defrost with re-evaporation of the defrost water

## Optional fittings and equipment – product configuration guide on page 12

R	BioLine stainless steel drawer 30 kg	€ 165	50	Chart recorder	€ 650		** Legs, wheels or for mounting on a plinth	€ 0
S	BioLine stainless steel drawer 40 kg	€ 220	82	60 Hz compressor	€ 0	31	Castors, 360° swivel	€ 40
C	BioLine dividers for stainless steel drawers (1 set)	€ 60	V	Reference container	€ 30	20/21	Door hinge – on right or left side	€ 0
P	BioLine perforated shelf in stainless steel	€ 80				80	Dual refrigeration circuit	€ 650
TTT	BioLine wire shelf in stainless steel	€ 55						

\*\* See page 80

\*\*\* R404A Available outside European Union

 Option codes

# BioMidi



Biostorage you can depend on

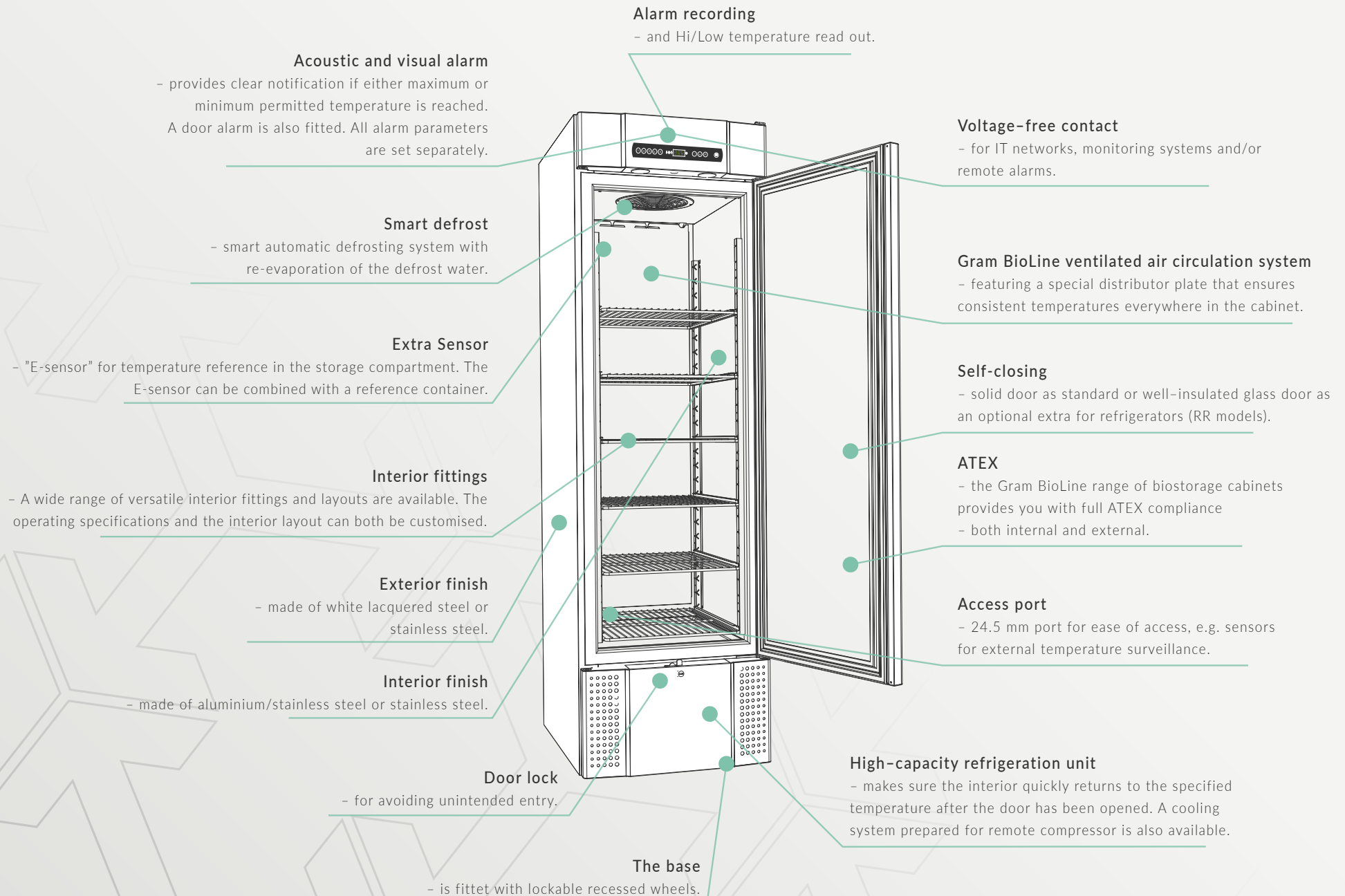

The BioMidi cabinet is designed to meet the majority of biomaterial refrigeration and freezer requirements, with very few limitations. The specifications include the major features from our top-of-the-range BioPlus model, making it the ideal choice when the ability to maintain stable temperatures is decisive in a purchasing decision.

The functional design ensures easy, ergonomically correct access to the storage space.

Available with capacities of 425 or 625 litres and in two different sizes, with white or stainless steel finish.

BioMidi refrigerators		
RR	Regular refrigeration	+2/+20°C
BioMidi freezers		
RF	Regular freezer	-25/-5°C
EF	Extended freezer	-40/-5°C

- 1 The user interface consist of large, easy to use buttons and an easy-to-read LED display. This helps make sure that adjusting cabinet settings is always a rapid, straightforward procedure.
- 2 Draught shield that minimizes cold loss when the outer door is opened is standard on the EF425 and optional extras to the other BioMidi variants.
- 3 Mounting the compressor in the base of the cabinet puts the interior space at an ideal working height, ensuring users better ergonomic positions and comfortable working heights.



# BioMidi RR425



**Ex II 3G Ex nA nC nL IIB T6 Gc (R134a)**

**Ex II 3G Ex nA nC nL IIB T5 Gc (R290)**

Price (white)

€ 3,350

Price (stainless steel)

€ 3,850

Technical specifications	
Temperature range	+2/+20°C
Ambient temperature range	Solid door +10/+43°C; glass door +10/+38°C
Control Unit	Gram Control Unit with voltage-free contact, E-sensor, acoustic and visual door and temperature alarms that can be programmed individually, alarm recording and offset function
Material: Interior*	Aluminium/stainless steel or stainless steel
Exterior	White lacquered steel or stainless steel
Ext. dimensions mm (W x D x H):	600 x 731 x 1980/2000
Net weight	Unpackaged net weight without optional fittings: 112 kg
Gross volume	425 litres/15.0 cubic feet
Net volume	303 litres/10.7 cubic feet
Modules for shelves and drawers	25 (see page 76)
Insulation	60 mm polyurethane with HFC-free cyclopentane propellant
K-Value	Solid door 0.3147 W/m²K; glass door 0.3147 W/m²K
Refrigerant	R290/ R134a***/prepared for external compressor
CO <sub>2</sub> e	R134a: 293
Refrigeration capacity at -10°C	R290 389 watt; R134a 279 watt
Energy consumption	1.27 kWh/24h (see page 73)
Connection	230 V, 50 Hz
Sound level	47.2 dB(A)
Air system	Gram BioLine ventilated air distribution system
Defrost system	Automatic smart defrost with re-evaporation of the defrost water

## Optional fittings and equipment – product configuration guide on page 12

A	BioLine aluminium drawer with length and cross dividers	€ 165	N	BioLine wire shelf with plastic coating	€ 40	V	Reference container	€ 30
R	BioLine stainless steel drawer 30 kg	€ 165	11	Glass door	€ 230	20/21	Door hinge – on right or left side	€ 0
S	BioLine stainless steel drawer 40 kg	€ 220	70	Draught shields (set of 3 inner doors)**	€ 385	84	Sound reduction kit	€ 165
C	BioLine dividers for stainless steel drawers (1 set)	€ 60	50	Chart recorder	€ 650			
P	BioLine perforated shelf in stainless steel	€ 80	81	Low-temperature protection	€ 135			
T	BioLine wire shelf in stainless steel	€ 55	82	60 Hz compressor	€ 0			
			69	DIN kit 58345	€ 165			

\* White version comes with internal sides in aluminium and bottom and backside of door in stainless steel. Stainless versions comes as all stainless

\*\* Cannot be combined with BioLine wire shelf with plastic coating

\*\*\* R134a available outside European Union

Option codes

# BioMidi RF425 ❄️ -25 °C



**Ex II 3G Ex nA nC nL IIB T3 Gc**

Price (white)  
**€ 3,900**

Price (stainless steel)  
**€ 4,400**

Technical specifications	
Temperature range	-25/-5°C
Ambient temperature range	+10/+43°C
Control Unit	Gram Control Unit with voltage-free contact, E-sensor, acoustic and visual door and temperature alarms that can be programmed individually, alarm recording and offset function
Material: Interior*	Aluminium/stainless steel or stainless steel
Exterior	White lacquered steel or stainless steel
Ext. dimensions mm (W x D x H):	600 x 731 x 1980/2000
Net weight	Unpackaged net weight without optional fittings: 112 kg
Gross volume	425 litres/15.0 cubic feet
Net volume	303 litres/10.7 cubic feet
Modules for shelves and drawers	25 (see page 76)
Insulation	60 mm polyurethane with HFC-free cyclopentane propellant
K-Value	Solid door 0.3147 W/m²K
Refrigerant	R290/R404A***/prepared for external compressor
CO <sub>2</sub> e	R404A: 784
Refrigeration capacity at -25°C	R290 374 watt; R404A 424 watt
Energy consumption	3.61 kWh/24h (see page 73)
Connection	230 V, 50 Hz
Sound level	46.3 dB(A)
Air system	Gram BioLine ventilated air distribution system
Defrost system	Automatic smart defrost with re-evaporation of the defrost water

## Optional fittings and equipment – product configuration guide on page 12

R	BioLine stainless steel drawer 30 kg	€ 165	N	BioLine wire shelf with plastic coating	€ 40	V	Reference container	€ 30
S	BioLine stainless steel drawer 40 kg	€ 220	70	Draught shields (set of 3 inner doors)**	€ 385	20/21	Door hinge – on right or left side	€ 0
C	BioLine dividers for stainless steel drawers (1 set)	€ 60	50	Chart recorder	€ 650	84	Sound reduction kit	€ 165
P	BioLine perforated shelf in stainless steel	€ 80	82	60 Hz compressor	€ 0			
T	BioLine wire shelf in stainless steel	€ 55						

\* White version comes with internal sides in aluminium and bottom and backside of door in stainless steel. Stainless versions comes as all stainless

\*\* Cannot be combined with BioLine wire shelf with plastic coating

\*\*\* R404A Available outside European Union

Option codes

# BioMidi RR625



**Ex II 3G Ex nA nC nL IIB T6 Gc (R134a)**

**Ex II 3G Ex nA nC nL IIB T5 Gc (R290)**

Price (white)  
**€ 3,770**

Price (stainless steel)  
**€ 4,270**

Technical specifications	
Temperature range	+2/+20°C
Ambient temperature range	Solid door +10/+43°C; glass door +10/+38°C
Control Unit	Gram Control Unit with voltage-free contact, E-sensor, acoustic and visual door and temperature alarms that can be programmed individually, alarm recording and offset function
Material: Interior*	Aluminium/stainless steel or stainless steel
Exterior	White lacquered steel or stainless steel
Ext. dimensions mm (W x D x H):	815 x 731 x 1980/2000
Net weight	Unpackaged net weight without optional fittings: 152 kg
Gross volume	625 litres/22.1 cubic feet
Net volume	451 litres/15.9 cubic feet
Modules for shelves and drawers	25 (see page 76)
Insulation	60 mm polyurethane with HFC-free cyclopentane propellant
K-Value	Solid door 0.3122 W/m²K; glass door 0.4912 W/m²K
Refrigerant	R290/ R134a***/prepared for external compressor
CO <sub>2</sub> e	R134a: 329
Refrigeration capacity at -10°C	R290 389 watt; R134a 314 watt
Energy consumption	1.30 kWh/24h (see page 73)
Connection	230 V, 50 Hz
Sound level	46.6 dB(A)
Air system	Gram BioLine ventilated air distribution system
Defrost system	Automatic smart defrost with re-evaporation of the defrost water

## Optional fittings and equipment – product configuration guide on page 12

A	BioLine aluminium drawer with length and cross dividers	€ 165	T	BioLine wire shelf in stainless steel	€ 55	81	Low-temperature protection	€ 135
R	BioLine stainless steel drawer 30 kg	€ 165	N	BioLine wire shelf with plastic coating	€ 40	82	60 Hz compressor	€ 0
S	BioLine stainless steel drawer 40 kg	€ 220	11	Glass door	€ 230	V	Reference container	€ 30
C	BioLine dividers for stainless steel drawers (1 set)	€ 60	70	Draught shields (set of 3 inner doors)**	€ 385	20/21	Door hinge – on right or left side	€ 0
P	BioLine perforated shelf in stainless steel	€ 80	50	Chart recorder	€ 650	84	Sound reduction kit	€ 165
			69	DIN kit 58345	€ 165			

\* The white lacquered steel version comes with internal sides in aluminium and bottom and backside of door in stainless steel. Stainless versions comes as all stainless.

\*\* Cannot be combined with BioLine wire shelf with plastic coating

\*\*\* R134a available outside European Union

Option codes



# BioMidi RF625 -25 °C

bioline



 II 3G Ex nA nC nL IIB T2 Gc

Price (white)  
€ 4,320

Price (stainless steel)  
€ 4,820

## Technical specifications

Temperature range	-25/-5°C
Ambient temperature range	+10/+43°C
Control Unit	Gram Control Unit with voltage-free contact, E-sensor, acoustic and visual door and temperature alarms that can be programmed individually, alarm recording and offset function
Material: Interior* Exterior	Aluminium/stainless steel or stainless steel White lacquered steel or stainless steel
Ext. dimensions mm (W x D x H):	815 x 731 x 1980/2000
Net weight	Unpackaged net weight without optional fittings: 152 kg
Gross volume	625 litres/22.1 cubic feet
Net volume	451 litres/15.9 cubic feet
Modules for shelves and drawers	25 (see page 76)
Insulation	60 mm polyurethane with HFC-free cyclopentane propellant
K-Value	Solid door 0.3122 W/m <sup>2</sup> K
Refrigerant	R290/R404A***/prepared for external compressor
CO <sub>2</sub> e	R404A: 941
Refrigeration capacity at -25°C	R290 512 watt; R404A 568 watt
Energy consumption	4.03 kWh/24h (see page 73)
Connection	230 V, 50 Hz
Sound level	48.4 dB(A)
Air system	Gram BioLine ventilated air distribution system
Defrost system	Automatic smart defrost with re-evaporation of the defrost water

## Optional fittings and equipment – product configuration guide on page 12

R	BioLine stainless steel drawer 30 kg	€ 165	N	BioLine wire shelf with plastic coating	€ 40	V	Reference container	€ 30
S	BioLine stainless steel drawer 40 kg	€ 220	70	Draught shields (set of 3 inner doors)**	€ 385	20/21	Door hinge – on right or left side	€ 0
C	BioLine dividers for stainless steel drawers (1 set)	€ 60	50	Chart recorder	€ 650	84	Sound reduction kit	€ 165
P	BioLine perforated shelf in stainless steel	€ 80	82	60 Hz compressor	€ 0			
T	BioLine wire shelf in stainless steel	€ 55						

\* The white lacquered steel version comes with internal sides in aluminium and bottom and backside of door in stainless steel. Stainless versions comes as all stainless.

\*\* Cannot be combined with BioLine wire shelf with plastic coating

\*\*\* R404A Available outside European Union

 Option codes

# BioMidi EF425 -40 °C

bioline

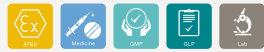

 II 3G Ex nA nC nL IIB T3 Gc

Price (white)  
€ 4,650

Price (stainless steel)  
€ 5,150

Technical specifications	
Temperature range	-40/-5°C
Ambient temperature range	+10/+30°C
Control Unit	Gram Control Unit with voltage-free contact, E-sensor, acoustic and visual door and temperature alarms that can be programmed individually, alarm recording and offset function
Material: Interior* Exterior	Aluminium/stainless steel or stainless steel and inner doors in PMMA White lacquered steel or stainless steel
Ext. dimensions mm (W x D x H):	622 x 731 x 1980/2000
Net weight	Unpackaged net weight without optional fittings: 112 kg
Gross volume	425 litres/15.0 cubic feet
Net volume	303 litres/10.7 cubic feet
Modules for shelves and drawers	25 (see page 76)
Insulation	60 mm polyurethane with HFC-free cyclopentane propellant
K-Value	Solid door 0.3147 W/m²K
Refrigerant	R290/R404A**/prepared for external compressor
CO <sub>2</sub> e	R404A: 1059
Refrigeration capacity at -40°C	R290 396 watt; R404A 378 watt
Energy consumption	8.93 kWh/24h (see page 73)
Connection	230 V, 50 Hz
Sound level	57.8 dB(A)
Air system	Gram BioLine ventilated air distribution system
Defrost system	Automatic smart defrost with re-evaporation of the defrost water

## Optional fittings and equipment – product configuration guide on page 12

R	BioLine stainless steel drawer 30 kg	€ 165	TTT	BioLine wire shelf in stainless steel	€ 55	V	Reference container	€ 30
S	BioLine stainless steel drawer 40 kg	€ 220	50	Chart recorder	€ 650	20/21	Door hinge – on right or left side	€ 0
C	BioLine dividers for stainless steel drawers (1 set)	€ 60	82	60 Hz compressor	€ 0	84	Sound reduction kit	€ 165
P	BioLine perforated shelf in stainless steel	€ 80						

\* The white lacquered steel version comes with internal sides in aluminium and bottom and backside of door in stainless steel. Stainless versions comes as all stainless.

\*\* R404A Available outside European Union

 Option codes



Biostorage you can depend on



# BioCompact II



Biostorage you can depend on

## Alarm recording

- and Hi/Low temperature read out.

## Acoustic and visual alarm

- provides clear notification if either maximum or minimum permitted temperature is reached. A door alarm is also fitted. All alarm parameters are set separately.

## Voltage-free contact

- for IT networks, monitoring systems and/or remote alarms.

## Smart defrost

- smart automatic defrosting system with re-evaporation of the defrost water.

## Extra Sensor

- "E-sensor" for temperature reference in the storage compartment. The E-sensor can be combined with a reference container.

## High-capacity refrigeration unit

- makes sure the interior quickly returns to the specified temperature after the door has been opened.

## Exterior finish

- made of white lacquered steel or stainless steel finish.

## Interior finish

- made of a durable one-piece moulded Polystyrene inner lining with U-shaped rails in the walls for mounting of shelves and drawers.

## Door lock

- for avoiding unintended entry.

## Gram BioLine ventilated air circulation system

- featuring a special distributor plate that ensures consistent temperatures everywhere in the cabinet.

## Self-closing

- solid door as standard or well-insulated glass door with LED light as an optional extra for refrigerators (RR models).

## ATEX

- the Gram BioLine range of biostorage cabinets provides you with full ATEX compliance - both internal and external.

## Access port

- 24.5 mm port for ease of access, e.g. sensors for external temperature surveillance.

## The base

- can be fitted with castors or feet, or for mounting on a plinth.

## Interior fittings

- a wide range of versatile interior fittings and layouts are available. The operating specifications and the interior layout can both be customised.



## Optional extra

Practical foot pedal door opener.

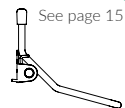

See page 15

# BioCompact II



- ATEX
- Medicine
- GMP
- GLP
- Lab

This is a compact refrigerator or freezer cabinet for a wide range of biostorage purposes where the prime focus is on dependability. The BioCompact II provides you with significantly better performance than any other cabinets in this segment for storing ordinary biomaterial under stable conditions. If you need to store different biomaterials at different times, this design gives you lots of ways to deal with individual storage needs, thanks to the versatile interior layout and a comprehensive selection of fixtures and fittings. The small footprint of this design also makes it the perfect biostorage unit for use in confined spaces.

Available with capacities of 125, 218, 250, 346 and 583 litres with either white or stainless steel finish.

BioCompact II refrigerators		
RR	Regular refrigeration	+2/+20°C
BioCompact II freezers		
RF	Regular freezer	-25/-5°C

- ① Gram MPC 4.6 control unit with temperature and door alarms and voltage-free contact.
- ② Extra sensor for providing a temperature reference within the storage is standard on all BioCompact II variants.
- ③ The refrigeration system based on a finned tube evaporator provides even better temperature stability and results in a storage place with no cold walls that can damage any delicate items stored in the cabinet.



# BioCompact II RR210



**II 3G Ex nA nC nL IIB T6 Gc (R290)**  
**II 3G Ex nA nC nL IIB T5 Gc (R134a)**  
**DTI 21ATEX0160X**



Price (white)  
**€ 1,780**

Price (stainless steel)  
**€ 1,890**

Technical specifications	
Temperature range	+2/+20°C
Ambient temperature range	Solid door +10/+35°C; glass door +10/+32°C
Control Unit	Gram Control Unit with voltage-free contact, E-sensor, acoustic and visual door and temperature alarms that can be programmed individually, alarm recording and offset function
Material: Interior	Polystyrene lining
Exterior	White lacquered steel or stainless steel finish
Ext. dimensions mm (W x D x H):	595 x 640 x 801/1001
Net weight	Unpackaged net weight without optional fittings: 46 kg
Gross volume	125 litres/4.4 cubic feet
Net volume	104 litres/3.7 cubic feet
Modules for shelves and drawers	4 x 430 mm + 3 x 300 mm (see page 76)
Insulation	50 mm polyurethane with HFC-free cyclopentane propellant
K-Value	Solid door 0.3559 W/m <sup>2</sup> K; glass door 0.4938 W/m <sup>2</sup> K
Refrigerant	R600a / R134a***
CO <sub>2</sub> e	R134a: 114
Refrigeration capacity at -10°C	R600a 154 watt; R134a 150 watt
Energy consumption	0.61 kWh/24h (see page 74)
Connection	230 V, 50 Hz
Sound level	36.5 dB(A)
Air system	Gram BioLine ventilated air distribution system
Defrost system	Automatic smart defrost with re-evaporation of the defrost water

## Optional fittings and equipment – product configuration guide on page 12

A	BioLine aluminium drawer (length/cross dividers) 420 mm	€ 165	W	BioLine wire shelf with plastic coating 430 mm	€ 30	69	DIN kit 58345	€ 165
AA	BioLine aluminium drawer (length/cross dividers) 300 mm	€ 155	WW	BioLine wire shelf with plastic coating 300 mm	€ 25	V	Reference container	€ 30
E	BioLine ABS drawer (length/cross dividers) 420 mm	€ 80	M	BioLine wire basket with plastic coating 430 mm	€ 50		*Legs, wheels	€ 90
P	BioLine perforated shelf in stainless steel 430 mm	€ 70	MM	BioLine wire basket with plastic coating 300 mm	€ 45	31	Castors, 360° swivel	€ 125
PP	BioLine perforated shelf in stainless steel 300 mm	€ 65	11	Glass door with LED light	€ 165	20/21	Door hinge – on right or left side	€ 0
T	BioLine wire shelf in stainless steel 430 mm	€ 50	81	Low-temperature protection	€ 135	91	Wall mounting	€ 180
TT	BioLine wire shelf in stainless steel 300 mm	€ 45	82	60 Hz compressor	€ 0	50	Chart recorder	€ 650
							Combination kit for 210/310	€ 110

\* See page 82

\*\*\* R134a available outside European Union

Option codes

# BioCompact II RF210 -25 °C



**II 3G Ex nA nC nL IIB T3 Gc**  
**DTI 21ATEX0160X**



Price (white)  
**€ 1,890**

Price (stainless steel)  
**€ 2,000**

Technical specifications	
Temperature range	-25/-5°C
Ambient temperature range	+10/+35°C
Control Unit	Gram Control Unit with voltage-free contact, E-sensor, acoustic and visual door and temperature alarms that can be programmed individually, alarm recording and offset function
Material: Interior	Polystyrene lining
Exterior	White lacquered steel or stainless steel finish
Ext. dimensions mm (W x D x H):	595 x 640 x 801/1001
Net weight	Unpackaged net weight without optional fittings: 46 kg
Gross volume	125 litres/4.4 cubic feet
Net volume	104 litres/3.7 cubic feet
Modules for shelves and drawers	4 x 430 mm + 3 x 300 mm (see page 76)
Insulation	50 mm polyurethane with HFC-free cyclopentane propellant
K-Value	Solid door 0.3559 W/m²K
Refrigerant	R600a / R134a***
CO <sub>2</sub> e	R134a: 100
Refrigeration capacity at -25°C	R600a 156 watt; R134a 149 watt
Energy consumption	1.53 kWh/24h (see page 74)
Connection	230 V, 50 Hz
Sound level	39.7 dB(A)
Air system	Gram BioLine ventilated air distribution system
Defrost system	Automatic smart defrost with re-evaporation of the defrost water

## Optional fittings and equipment – product configuration guide on page 12

A	BioLine aluminium drawer (length dividers) 420 mm	€ 165	W	BioLine wire shelf with plastic coating 430 mm	€ 30	V	Reference container	€ 30
AA	BioLine aluminium drawer (length dividers) 300 mm	€ 155	WW	BioLine wire shelf with plastic coating 300 mm	€ 25		*Legs, wheels	€ 90
E	BioLine ABS drawer (length dividers) 420 mm	€ 80	M	BioLine wire basket with plastic coating 430 mm	€ 50	31	Castors, 360° swivel	€ 125
P	BioLine perforated shelf in stainless steel 430 mm	€ 70	MM	BioLine wire basket with plastic coating 300 mm	€ 45	20/21	Door hinge – on right or left side	€ 0
PP	BioLine perforated shelf in stainless steel 300 mm	€ 65	82	60 Hz compressor	€ 0	91	Wall mounting	€ 180
T	BioLine wire shelf in stainless steel 430 mm	€ 50				50	Chart recorder	€ 650
TT	BioLine wire shelf in stainless steel 300 mm	€ 45					Combination kit for 210/310	€ 110

\* See page 82

\*\*\* R134a available outside European Union

# BioCompact II RR310



**II 3G Ex nA nC nL IIB T6 Gc (R290)**  
**II 3G Ex nA nC nL IIB T5 Gc (134a)**  
**DTI 21ATEX0160X**

Price (white)  
**€ 1,940**

Price (stainless steel)  
**€ 2,050**

Technical specifications	
Temperature range	+2/+20°C
Ambient temperature range	Solid door +10/+35°C; glass door +10/+32°C
Control Unit	Gram Control Unit with voltage-free contact, E-sensor, acoustic and visual door and temperature alarms that can be programmed individually, alarm recording hi/low function, and offset function
Material: Interior	Polystyrene lining
Exterior	White lacquered steel or stainless steel finish
Ext. dimensions mm (W x D x H):	595 x 640 x 1190/1390
Net weight	Unpackaged net weight without optional fittings: 55 kg
Gross volume	218 litres/7.8 cubic feet
Net volume	189 litres/6.7 cubic feet
Modules for shelves and drawers	11 x 430 mm + 3 x 300 mm (see page 76)
Insulation	50 mm polyurethane with HFC-free cyclopentane propellant
K-Value	Solid door 0.3550 W/m²K; glass door 0.5061W/m²K
Refrigerant	R600a / R134a***
CO <sub>2</sub> e	R134a: 136
Refrigeration capacity at -10°C	R600a 154 watt; R134a 173 watt
Energy consumption	0.63 kWh/24h (see page 74)
Connection	220 V, 50 Hz
Sound level	38.6 dB(A)
Air system	Gram BioLine ventilated air distribution system
Defrost system	Automatic smart defrost with re-evaporation of the defrost water

## Optional fittings and equipment – product configuration guide on page 12

A	BioLine aluminium drawer (length/cross dividers) 420 mm	€ 165	W	BioLine wire shelf with plastic coating 430 mm	€ 30	82	60 Hz compressor	€ 0
AA	BioLine aluminium drawer (length/cross dividers) 300 mm	€ 155	WW	BioLine wire shelf with plastic coating 300 mm	€ 25	V	Reference container	€ 30
E	BioLine ABS drawer (length/cross dividers) 420 mm	€ 80	M	BioLine wire basket with plastic coating 430 mm	€ 50		*Legs, wheels	€ 90
P	BioLine perforated shelf in stainless steel 430 mm	€ 70	MM	BioLine wire basket with plastic coating 300 mm	€ 45	31	Castors, 360° swivel	€ 125
PP	BioLine perforated shelf in stainless steel 300 mm	€ 65	11	Glass door with LED light	€ 165	20/21	Door hinge – on right or left side	€ 0
T	BioLine wire shelf in stainless steel 430 mm	€ 50	81	Low-temperature protection	€ 135	50	Chart recorder	€ 650
TT	BioLine wire shelf in stainless steel 300 mm	€ 45	69	DIN kit 58345	€ 165	91	Wall mounting	€ 180
							Combination kit for 210/310	€ 110

\* See page 82

\*\*\* R134a available outside European Union

Option codes



# BioCompact II RF310 ❄️ -25 °C



**Ex II 3G Ex nA nC nL IIB T3 Gc**  
**DTI 21ATEX0160X**

Price (white)  
**€ 2,050**

Price (stainless steel)  
**€ 2,160**

Technical specifications	
Temperature range	-25/-5°C
Ambient temperature range	+10/+35°C
Control Unit	Gram Control Unit with voltage-free contact, E-sensor, acoustic and visual door and temperature alarms that can be programmed individually, alarm recording hi/low function, and offset function
Material: Interior	Polystyrene lining
Exterior	White lacquered steel or stainless steel finish
Ext. dimensions mm (W x D x H):	595 x 640 x 1190/1390
Net weight	Unpackaged net weight without optional fittings: 55 kg
Gross volume	218 litres/7.8 cubic feet
Net volume	189 litres/6.7 cubic feet
Modules for shelves and drawers	11 x 430 mm + 3 x 300 mm (see page 76)
Insulation	50 mm polyurethane with HFC-free cyclopentane propellant
K-Value	Solid door 0.3550 W/m²K
Refrigerant	R600a / R134a***
CO <sub>2</sub> e	R134a: 114
Refrigeration capacity at -25°C	R600a 204 watt; R134a 216 watt
Energy consumption	1.69 kWh/24h (see page 74)
Connection	220 V, 50 Hz
Sound level	39.6 dB(A)
Air system	Gram BioLine ventilated air distribution system
Defrost system	Automatic smart defrost with re-evaporation of the defrost water

## Optional fittings and equipment – product configuration guide on page 12

A	BioLine aluminium drawer (length dividers) 420 mm	€ 165	W	BioLine wire shelf with plastic coating 430 mm	€ 30	V	Reference container	€ 30
AA	BioLine aluminium drawer (length dividers) 300 mm	€ 155	WW	BioLine wire shelf with plastic coating 300 mm	€ 25		*Legs, wheels	€ 90
E	BioLine ABS drawer (length dividers) 420 mm	€ 80	M	BioLine wire basket with plastic coating 430 mm	€ 50	31	Castors, 360° swivel	€ 125
P	BioLine perforated shelf in stainless steel 430 mm	€ 70	MM	BioLine wire basket with plastic coating 300 mm	€ 45	20/21	Door hinge – on right or left side	€ 0
PP	BioLine perforated shelf in stainless steel 300 mm	€ 65	82	60 Hz compressor	€ 0	91	Wall mounting	€ 180
T	BioLine wire shelf in stainless steel 430 mm	€ 50				50	Chart recorder	€ 650
TT	BioLine wire shelf in stainless steel 300 mm	€ 45					Combination kit for 210/310	€ 110

\* See page 82

\*\*\* R134a available outside European Union

Option codes

# BioCompact II RR410



**II 3G Ex nA nC nL IIB T6 Gc (R290)**

**II 3G Ex nA nC nL IIB T5 Gc (R134a)**

**DTI 21ATEX0160X**

Price (white)

€ 2,100

Price (stainless steel)

€ 2,210

Technical specifications	
Temperature range	+2/+20°C
Ambient temperature range	Solid door +10/+35°C; glass door +10/+32°C
Control Unit	Gram Control Unit with voltage-free contact, E-sensor, acoustic and visual door and temperature alarms that can be programmed individually, alarm recording and offset function
Material: Interior	Polystyrene lining
Exterior	White lacquered steel or stainless steel finish
Ext. dimensions mm (W x D x H):	595 x 640 x 1776/1976
Net weight	Unpackaged net weight without optional fittings: 78 kg
Gross volume	346 litres/12.3 cubic feet
Net volume	312 litres/11.1 cubic feet
Modules for shelves and drawers	22 x 430 mm + 3 x 300 mm (see page 76)
Insulation	50 mm polyurethane with HFC-free cyclopentane propellant
K-Value	Solid door 0.3543 W/m <sup>2</sup> K; glass door 0.5168 W/m <sup>2</sup> K
Refrigerant	R600a / R134a***
CO <sub>2</sub> e	R134a: 172
Refrigeration capacity at -10°C	R600a 207 watt; R134a 173 watt
Energy consumption	0.73 kWh/24h (see page 74)
Connection	230 V, 50 Hz
Sound level	35.1 dB(A)
Air system	Gram BioLine ventilated air distribution system
Defrost system	Automatic smart defrost with re-evaporation of the defrost water

## Optional fittings and equipment – product configuration guide on page 12

A	BioLine aluminium drawer (length/cross dividers) 420 mm	€ 165	W	BioLine wire shelf with plastic coating 430 mm	€ 30	69	DIN kit 58345	€ 165
AA	BioLine aluminium drawer (length/cross dividers) 300 mm	€ 155	WW	BioLine wire shelf with plastic coating 300 mm	€ 25		*Legs, wheels	€ 0
E	BioLine ABS drawer (length/cross) dividers 420 mm	€ 80	M	BioLine wire basket with plastic coating 430 mm	€ 50	31	Castors, 360° swivel	€ 40
P	BioLine perforated shelf in stainless steel 430 mm	€ 70	MM	BioLine wire basket with plastic coating 300 mm	€ 45	20/21	Door hinge – on right or left side	€ 0
PP	BioLine perforated shelf in stainless steel 300 mm	€ 65	11	Glass door with LED light	€ 165	91	Wall mounting	€ 180
T	BioLine wire shelf in stainless steel 430 mm	€ 50	81	Low-temperature protection	€ 135	50	Chart recorder	€ 650
TT	BioLine wire shelf in stainless steel 300 mm	€ 45	82	60 Hz compressor	€ 0		Pedal door opener	€ 110
						V	Reference container	€ 30

\* See page 84

\*\*\* R134a available outside European Union

Option codes

# BioCompact II RF410 -25 °C



**II 3G Ex nA nC nL IIB T3 Gc  
DTI 21ATEX0160X**

Price (white)  
**€ 2,210**

Price (stainless steel)  
**€ 2,320**

Technical specifications	
Temperature range	-25/-5°C
Ambient temperature range	+10/+35°C
Control Unit	Gram Control Unit with voltage-free contact, E-sensor, acoustic and visual door and temperature alarms that can be programmed individually, alarm recording and offset function
Material: Interior Exterior	Polystyrene lining White lacquered steel or stainless steel finish
Ext. dimensions mm (W x D x H):	595 x 640 x 1776/1976
Net weight	Unpackaged net weight without optional fittings: 78 kg
Gross volume	346 litres/12.3 cubic feet
Net volume	312 litres/11.1 cubic feet
Modules for shelves and drawers	22 x 430 mm + 3 x 300 mm (see page 76)
Insulation	50 mm polyurethane with HFC-free cyclopentane propellant
K-Value	Solid door 0.3543 W/m²K
Refrigerant	R600a / R134a***
CO <sub>2</sub> e	R134a: 136
Refrigeration capacity at -25°C	R600a 204 watt; R134a 216 watt
Energy consumption	2.13 kWh/24h (see page 74)
Connection	230 V, 50 Hz
Sound level	38.6 dB(A)
Air system	Gram BioLine ventilated air distribution system
Defrost system	Automatic smart defrost with re-evaporation of the defrost water

## Optional fittings and equipment – product configuration guide on page 12

A	BioLine aluminium drawer (length dividers) 420 mm	€ 165	W	BioLine wire shelf with plastic coating 430 mm	€ 30	V	Reference container	€ 30
AA	BioLine aluminium drawer (length dividers) 300 mm	€ 155	WW	BioLine wire shelf with plastic coating 300 mm	€ 25		*Legs, wheels	€ 0
E	BioLine ABS drawer (length dividers) 420 mm	€ 80	M	BioLine wire basket with plastic coating 430 mm	€ 50	31	Castors, 360° swivel	€ 40
P	BioLine perforated shelf in stainless steel 430 mm	€ 70	MM	BioLine wire basket with plastic coating 300 mm	€ 45	20/21	Door hinge – on right or left side	€ 0
PP	BioLine perforated shelf in stainless steel 300 mm	€ 65	82	60 Hz compressor	€ 0	91	Wall mounting	€ 180
T	BioLine wire shelf in stainless steel 430 mm	€ 50				50	Chart recorder	€ 650
TT	BioLine wire shelf in stainless steel 300 mm	€ 45					Pedal door opener	€ 110

\* See page 84

\*\*\* R134a available outside European Union

 Option codes

# BioCompact II RR610



II 3G Ex nA nC nL IIB T6 Gc

Price (white)  
€ 2,660

Price (stainless steel)  
€ 2,760

Technical specifications	
Temperature range	+2/+20°C
Ambient temperature range	Solid door +10/+43°C; Glass door +10/+38°C
Control Unit	Gram Control Unit with voltage-free contact, E-sensor, acoustic and visual door and temperature alarms that can be programmed individually, alarm recording and offset function
Material: Interior Exterior	Polystyrene lining with wall rails in stainless steel White lacquered steel or stainless steel finish
Ext. dimensions mm (W x D x H):	695 x 875 x 1874/2075
Net weight	Unpackaged net weight without optional fittings: 114 kg
Gross volume	583 litres/20.6 cubic feet
Net volume	419 litres/16.7 cubic feet
Modules for shelves and drawers	24 (see page 76)
Insulation (mm)	60 mm polyurethane with HFC-free cyclopentane propellant
K-Value	Solid door 0.3118 W/m <sup>2</sup> K; glass door 0.4634 W/m <sup>2</sup> K
Refrigerant	R600a / R134a***
CO <sub>2</sub> e	R134a: 329
Refrigeration capacity at -10°C	R600a 354 watt; R134a 314 watt
Energy consumption	1.15 kWh/24h (see page 74)
Connection	230 V, 50 Hz
Sound level	44,2 dB(A)
Air system	Gram BioLine ventilated air distribution system
Defrost system	Automatic smart defrost with re-evaporation of the defrost water

## Optional fittings and equipment – product configuration guide on page 12

A	BioLine aluminium drawer with length and cross dividers	€ 165	50	Chart recorder	€ 650		*Legs, wheels	€ 0
R	BioLine stainless steel drawer 30 kg	€ 165	81	Low-temperature protection	€ 135	31	Castors, 360° swivel	€ 40
S	BioLine stainless steel drawer 40 kg	€ 220	82	60 Hz compressor	€ 0	20/21	Door hinge – on right or left side	€ 0
C	BioLine dividers for stainless steel drawers (1 set)	€ 60	V	Reference container	€ 30	11	Glass door with LED light	€ 230
P	BioLine perforated shelf in stainless steel	€ 80	69	DIN kit 58345	€ 165		Pedal door opener	€ 110
T	BioLine wire shelf in stainless steel	€ 55						
N	BioLine wire shelf with plastic coating	€ 40						

\* See page 84

\*\*\* R134a available outside European Union

Option codes

# BioCompact II RF610 ❄️ -25 °C



II 3G Ex nA nC nL IIB T2 Gc

Price (white)  
€ 2,960

Price (stainless steel)  
€ 3,060

Technical specifications	
Temperature range	-25/-5°C
Ambient temperature range	+10/+43°C
Control Unit	Gram Control Unit with voltage-free contact, E-sensor, acoustic and visual door and temperature alarms that can be programmed individually, alarm recording and offset function
Material: Interior Exterior	Polystyrene lining with wall rails in stainless steel White lacquered steel or stainless steel finish
Ext. dimensions mm (W x D x H):	695 x 875 x 1874/2075
Net weight	Unpackaged net weight without optional fittings: 114 kg
Gross volume	583 litres/20.6 cubic feet
Net volume	419 litres/16.7 cubic feet
Modules for shelves and drawers	24 (see page 76)
Insulation	60 mm polyurethane with HFC-free cyclopentane propellant
K-Value	Solid door 0.3118 W/m²K
Refrigerant	R290/R404A**
CO <sub>2</sub> e	R404A: 863
Refrigeration capacity at -25°C	R290 512 watt; R404A 616 watt
Energy consumption	3.88 kWh/24h (see page 74)
Connection	230 V, 50 Hz
Sound level	48.6 dB(A)
Air system	Gram BioLine ventilated air distribution system
Defrost system	Automatic smart defrost with re-evaporation of the defrost water

## Optional fittings and equipment – product configuration guide on page 12

R	BioLine stainless steel drawer 30 kg	€ 165	50	Chart recorder	€ 650		*Legs, wheels	€ 0
S	BioLine stainless steel drawer 40 kg	€ 220	82	60 Hz compressor	€ 0	31	Castors, 360° swivel	€ 40
C	BioLine dividers for stainless steel drawers (1 set)	€ 60	V	Reference container	€ 30	20/21	Door hinge – on right or left side	€ 0
P	BioLine perforated shelf in stainless steel	€ 80					Pedal door opener	€ 110
T	BioLine wire shelf in stainless steel	€ 55						
N	BioLine wire shelf with plastic coating	€ 40						

\* See page 84

\*\* R404A Available outside European Union

Option codes

# BioCompact II RR210/RF210



**II 3G Ex nA nC nL IIB T3 Gc**  
**DTI 21ATEX0160X**

Price (white)  
**€ 3,870**

Price (stainless steel)  
**€ 4,090**

Technical specifications	
Temperature range	+2/+20°C and -25/-5°C
Ambient temperature range	Solid door +10/+35°C; glass door +10/+32°C
Control Unit	Gram Control Unit with voltage-free contact, E-sensor, acoustic and visual door and temperature alarms that can be programmed individually, alarm recording and offset function
Material: Interior	Polystyrene lining
Material: Exterior	White lacquered steel or stainless steel finish
Ext. dimensions mm (W x D x H):	595 x 640 x 1602/1802
Net weight	Unpackaged net weight without optional fittings: 92 kg
Gross volume	125 litres/4.4 cubic feet and 125 litres/4.4 cubic feet
Net volume	104 litres/3.7 cubic feet and 104 litres/3.7 cubic feet
Modules for shelves and drawers	4 x 430 mm + 3 x 300 mm and 4 x 430 mm + 3 x 300 mm (see page 76)
Insulation	50 mm polyurethane with HFC-free cyclopentane propellant
K-Value	Solid door 0.3559 W/m <sup>2</sup> K; glass door 0.4938 W/m <sup>2</sup> K
Refrigerant	R600a / R134a***
CO <sub>2</sub> e	RR210 R134a: 114 / RF210 R134a: 100
Refrigeration capacity at -10°C	RR: R600a 154 watt; R134a 150 watt
Refrigeration capacity at -25°C	RF: R600a 156 watt; R134a 149 watt
Energy consumption	2.14 kWh/24h (see page 74)
Connection	230 V, 50 Hz
Sound level	41.4 dB(A)
Air system	Gram BioLine ventilated air distribution system
Defrost system	Automatic smart defrost with re-evaporation of the defrost water

## Optional fittings and equipment – product configuration guide on page 12

A	BioLine aluminium drawer (length/cross dividers) 420 mm	€ 165	W	BioLine wire shelf with plastic coating 430 mm	€ 30	81	Low-temperature protection (RR only)	€ 135
AA	BioLine aluminium drawer (length/cross dividers) 300 mm	€ 155	WW	BioLine wire shelf with plastic coating 300 mm	€ 25	82	60 Hz compressor	€ 0
A	BioLine aluminium drawer (length dividers) 420 mm	€ 165	M	BioLine wire basket with plastic coating 430 mm	€ 50	V	Reference container (per unit)	€ 30
AA	BioLine aluminium drawer (length dividers) 300 mm	€ 155	MM	BioLine wire basket with plastic coating 300 mm	€ 45		*Legs, wheels	€ 0
E	BioLine ABS drawer (length/cross dividers) 420 mm	€ 80	11	Glass door with LED light (RR only)	€ 165	31	Castors, 360° swivel	€ 40
E	BioLine ABS drawer (length dividers) 420 mm	€ 80	69	DIN kit 58345 (RR only)	€ 165	20/21	Door hinge – on right or left side	€ 0
P	BioLine perforated shelf in stainless steel 430 mm	€ 70				91	Wall mounting	€ 180
PP	BioLine perforated shelf in stainless steel 300 mm	€ 65				50	Chart recorder (per unit)	€ 650
T	BioLine wire shelf in stainless steel 430 mm	€ 50						
TT	BioLine wire shelf in stainless steel 300 mm	€ 45						

\* See page 83

\*\*\* R134a available outside European Union

# BioCompact II RR310/RF210\*



**II 3G Ex nA nC nL IIB T3 Gc**  
**DTI 21ATEX0160X**

Price (white)  
**€ 4,030**

Price (stainless steel)  
**€ 4,250**

Technical specifications new pic - specs updated	
Temperature range	+2/+20°C and -25/-5°C
Ambient temperature range	Solid door +10/+35°C; glass door +10/+32°C
Control Unit	Gram Control Unit with voltage-free contact, E-sensor, acoustic and visual door and temperature alarms that can be programmed individually, alarm recording and offset function
Material: Interior Exterior	Polystyrene lining White lacquered steel or stainless steel finish
Dimensions mm (W x D x H):	595 x 640 x 1991/2191
Net weight	Unpackaged net weight without optional fittings: 101 kg
Gross volume	218 litres/7.8 cubic feet and 125 litres/4.4 cubic feet
Net volume	189 litres/6.7 cubic feet and 104 litres/3.7 cubic feet
Modules for shelves and drawers	4 x 430 mm + 3 x 300 mm and 4 x 430 mm + 3 x 300 mm (see page 76)
Insulation	50 mm polyurethane with HFC-free cyclopentane propellant
K-Value	RR310: Solid door 0.3550 W/m <sup>2</sup> K; glass door 0.5061 W/m <sup>2</sup> K RF210: Solid door 0.3559 W/m <sup>2</sup> K
Refrigerant	R600a / R134a***
CO <sub>2</sub> e	RR310 R134a: 136 / RF210 R134a: 100
Refrigeration capacity at -10°C Refrigeration capacity at -25°C	R600a 154 watt; R134a 173 watt R600a 156 watt; R134a 149 watt
Energy consumption	2.16 kWh/24h (see page 74)
Connection	230 V, 50 Hz
Sound level	42.2 dB(A)
Air system	Gram BioLine ventilated air distribution system
Defrost system	Automatic smart defrost with re-evaporation of the defrost water

## Optional fittings and equipment – product configuration guide on page 12

A	BioLine aluminium drawer (length/cross dividers) 420 mm	€ 165	W	BioLine wire shelf with plastic coating 430 mm	€ 30	81	Low-temperature protection (RR only)	€ 135
AA	BioLine aluminium drawer (length/cross dividers) 300 mm	€ 155	WW	BioLine wire shelf with plastic coating 300 mm	€ 25	82	60 Hz compressor	€ 0
A	BioLine aluminium drawer (length dividers) 420 mm	€ 165	M	BioLine wire basket with plastic coating 430 mm	€ 50	V	Reference container (per unit)	€ 30
AA	BioLine aluminium drawer (length dividers) 300 mm	€ 155	MM	BioLine wire basket with plastic coating 300 mm	€ 45		**Legs, wheels	€ 0
E	BioLine ABS drawer (length/cross dividers) 420 mm	€ 80	11	Glass door with LED light (RR only)	€ 165	31	Castors, 360° swivel	€ 40
E	BioLine ABS drawer (length dividers) 420 mm	€ 80	69	DIN kit 58345 (RR only)	€ 165	20/21	Door hinge – on right or left side	€ 0
P	BioLine perforated shelf in stainless steel 430 mm	€ 70				91	Wall mounting	€ 180
PP	BioLine perforated shelf in stainless steel 300 mm	€ 65				50	Chart recorder (per unit)	€ 650
T	BioLine wire shelf in stainless steel 430 mm	€ 50						
TT	BioLine wire shelf in stainless steel 300 mm	€ 45						

\* Comes in two boxes and must be assembled before use

\*\* See page 83

\*\*\* R134a available outside European Union

Option codes

# Models and options

	ExGuard	BioUltra	BioPlus	BioMidi	BioCompact II
<b>Temperature range</b>					
Refrigerators +2/+20°C				●	●
Refrigerators -2/+20°C	●		●		
Freezers -25/-5°C			●	●	●
Freezers -35/-5°C			●		
Freezers -40/-5°C				●	
Freezers -86/-60°C		●			
<b>Materials exterior/interior</b>					
White/stainless	●		●		
White/White, stainless		●			
Stainless/stainless	●	●	●	●	
White/aluminium, stainless				●	
White/Polystyrene					●
Stainless/Polystyrene					●
<b>Technical specifications</b>					
Gram BioLine ventilated air distribution system	●		●	●	●
Dry cooling	●		● (ER)		
Smart Defrost	●		●	●	●
Defrost shield			● (RF/EF)	● (RF/EF)	
Automatic re-evaporation of defrost water	●		●	●	●
Defrost interval, adjustable	●		●	●	●
Dual refrigeration circuit			○ (W/1270/1400)		
Voltage-free contact	●	●	●	●	●
Low-temperature protection*			○ (ER)	○ (RR)	○ (RR)
E-sensor	●	●	●	●	●
Chart recorder		○	○	○	○
Acoustic and visual alarm for upper and lower temperature limits	●	●	●	●	●
Acoustic and visual alarm for open door	●		●	●	●
Separate setting of all alarm parameters	●	●	●	●	●
Alarm recording	●	●	●	●	●
High/low temperature read-out	●	●	●	●	●
Offset of temperature sensor(s)	●	●	●	●	●
Water cooled condensor - Hybrid		○			

\*Voids ATEX compliance

● Included

○ Available options



# Standard and options



	ExGuard	BioUltra	BioPlus	BioMidi	BioCompact II
<b>Technical specifications continued</b>					
Key pad lock	●	●	●	●	●
Service program	●	●	●	●	●
Temperature scale in Celsius and Fahrenheit	●	●	●	●	●
230V, 50Hz	●		●	●	●
230V, 60Hz		○ (RF with HFC)	● (ER with HFC) ○ (RF / EF with HFC)	● (RR with HFC) ○ (RF with HFC)	○ (HFC)
<b>Exterior equipment</b>					
Solid door	●	●	●	●	●
Glass door	○ (ER)		○ (ER)	○ (RR)	
Glass door with LED light					○ (RR)
Pedal door opener			● (not EF)		○
Self closing door	●		●	●	●
Legs/castors/plinth	●		●	● (Recessed wheels)	●/○ (210/310)
Castors, 360° swivel	○	● (levelling castors)	○/● (1270/1400)		○
Wall mounting					○ (210/310/410)
Door lock	●	●	●	●	●
LED display	●	●	●	●	●
Visual indicator for alarm	●	● (no door alarm)	●	●	●
Halogen lights	●		●	●	
<b>Interior equipment</b>					
Wire shelf, plastic coated			○ (not EF, 930 or opt.70)	○ (not EF or opt. 70)	○
Wire shelf, stainless steel	○		○	○	○
Perforated shelf, stainless steel	○	●	○	○	○
Wire basket					○ (210/310/410)
Aluminium drawer with length/cross dividers			○ (ER, not 930)	○ (RR)	○ (RR)
Aluminium drawer with length dividers					○ (RF210/310/410)
ABS drawer with length/cross dividers					○ (RR210, 310, 410)
ABS drawer with length dividers					○ (RF210/310/410)
Stainless steel drawer, 30 kg			○ (not 930)	○	○ (610)
Stainless steel drawer, 40 kg	○		○	○	○ (610)
BioLine dividers for stainless steel drawers	○		○	○	○ (610)
Draught shields		●	○ (not 930)/● (EF)	○/● (EF)	
Reference container	○		○	○	○
DIN kit			○ (ER)	○ (RR)	○ (RR)
Noise reduction kit				○	

● Included

○ Available options

# Products and Prices · ExGuard

## ExGuard – Refrigerators

ER600W (white) .....	€ 6,990
ER600W (stainless steel) .....	€ 7,240

## Additional equipment and fittings

	Factory-fitted	Supplied separately
BioLine stainless steel drawer 40 Kg.....	€ 220	€ 250
BioLine dividers for stainless steel drawers (1 set).....	€ 60	€ 90
BioLine perforated shelf in stainless steel.....	€ 80	€ 100
BioLine wire shelf in stainless steel.....	€ 55	€ 75
Door hinge – on right or left side.....	€ 0	N/A
Legs, castors/wheels or for mounting on a plinth .....	€ 0	€ 110
Castors, 360° swivel .....	€ 40	€ 150
Glass door, single door (only ER) .....	€ 230	N/A
Reference container .....	€ 30	€ 50
Shelf supporters (additional).....	N/A	€ 35

# Products and Prices · BioUltra / BioPlus



## BioUltra – Freezer

UL570 (white) .....	€ 9,540
UL570 (stainless steel) .....	€ 9,990

## Additional equipment and fittings

	Factory-fitted	Supplied separately
Chart recorder .....	€ 650	N/A
Chart recorder, paper – 100 pcs.....	N/A	€ 110
Chart recorder, pens .....	N/A	€ 45
BioLine perforated shelf in stainless steel.....	N/A	€ 100
Door hinge – on right or left side.....	€ 0	N/A
Water cooled - hybrid.....	€ 2,035	N/A
Racks/boxes – Please see on page 23		

## BioPlus – Refrigerators

ER500 (white).....	€ 4,690
ER500 (stainless steel) .....	€ 4,940
ER600D (white) .....	€ 4,840
ER600D (stainless steel) .....	€ 5,090
ER600W (white) .....	€ 4,840
ER600W (stainless steel).....	€ 5,090
ER660D (white) .....	€ 4,990
ER660D (stainless steel) .....	€ 5,240
ER660W (white) .....	€ 4,990
ER660W (stainless steel).....	€ 5,240
ER930 (white).....	€ 5,440
ER930 (stainless steel).....	€ 5,690
ER1270 (white).....	€ 6,790
ER1270 (stainless steel).....	€ 7,240
ER1400 (white).....	€ 6,990
ER1400 (stainless steel).....	€ 7,440

## BioPlus – Freezers

RF500 (white).....	€ 5,240
RF500 (stainless steel).....	€ 5,490
RF600D (white) .....	€ 5,390
RF600D (stainless steel) .....	€ 5,640
RF600W (white) .....	€ 5,390
RF600W (stainless steel).....	€ 5,640
RF660D (white) .....	€ 5,540
RF660D (stainless steel) .....	€ 5,790
RF660W (white) .....	€ 5,540
RF660W (stainless steel).....	€ 5,790
RF930 (white).....	€ 5,990
RF930 (stainless steel).....	€ 6,240
RF1270 (white).....	€ 7,340
RF1270 (stainless steel).....	€ 7,790
RF1400 (white).....	€ 7,540
RF1400 (stainless steel).....	€ 7,990
EF600W -35°C (white).....	€ 6,140
EF600W -35°C (stainless steel).....	€ 6,390
EF660W -35°C (white).....	€ 6,290
EF660W -35°C (stainless steel).....	€ 6,540

## Additional equipment and fittings

	Factory-fitted	Supplied separately
BioLine aluminium drawer with length and cross dividers .....	€ 165	€ 195
BioLine stainless steel drawer 30 kg .....	€ 165	€ 195
BioLine stainless steel drawer 40 Kg.....	€ 220	€ 250
BioLine dividers for stainless steel drawers (1 set).....	€ 60	€ 90
BioLine perforated shelf in stainless steel.....	€ 80	€ 100
BioLine wire shelf in stainless steel.....	€ 55	€ 75
BioLine wire shelf with plastic coating .....	€ 40	€ 60
Door hinge – on right or left side.....	€ 0	N/A
Legs, castors/wheels or for mounting on a plinth .....	€ 0	€ 110
Castors, 360° swivel .....	€ 40	€ 150
Chart recorder .....	€ 650	N/A
Chart recorder, paper – 100 pcs.....	N/A	€ 110
Chart recorder, pen - 1 pcs .....	N/A	€ 45
Dual refrigeration circuit (only W, 1270, 1400) .....	€ 650	N/A
60 Hz compressor .....	€ 0	N/A
Glass door, single door (only ER) .....	€ 230	N/A
Glass doors, double door (only ER, 1270 or 1400) .....	€ 460	N/A
Draught shields (500, 600 or 660) .....	€ 385	€ 435
Draught shields (1270 or 1400) .....	€ 770	€ 870
Low-temperature protection (only ER).....	€ 135	€ 165
Reference container .....	€ 30	€ 50
BioLine divider kit for aluminium drawer (length and cross dividers) ...	N/A	€ 50
Shelf supporters (additional).....	N/A	€ 35
DIN-Kit.....	€ 165	N/A

# Products and Prices · BioMidi

## BioMidi - Refrigerators

RR425 (white).....	€ 3,350
RR425 (stainless steel).....	€ 3,850
RR625 (white).....	€ 3,770
RR625 (stainless steel).....	€ 4,270

## BioMidi - Freezer

RF425 (white).....	€ 3,900
RF425 (stainless steel).....	€ 4,400
RF625 (white).....	€ 4,320
RF625 (stainless steel).....	€ 4,820
EF425 -40°C (white).....	€ 4,650
EF425 -40°C (stainless steel).....	€ 5,150

## Additional equipment and fittings

	Factory-fitted	Supplied separately
BioLine aluminium drawer with length and cross dividers .....	€ 165	€ 195
BioLine stainless steel drawer 30 kg .....	€ 165	€ 195
BioLine stainless steel drawer 40 kg .....	€ 220	€ 250
BioLine dividers for stainless steel drawers (1 set).....	€ 60	€ 90
BioLine perforated shelf in stainless steel.....	€ 80	€ 100
BioLine wire shelf in stainless steel.....	€ 55	€ 75
BioLine wire shelf with plastic coating .....	€ 40	€ 60
Door hinge - on right or left side.....	€ 0	N/A
Chart recorder .....	€ 650	N/A
Chart recorder, paper - 100 pcs.....	N/A	€ 110
Chart recorder, pen - 1 pcs. ....	N/A	€ 45
60 Hz compressor .....	€ 0	N/A
Glass door, single door (only RR) .....	€ 230	N/A
Draught shields .....	€ 385	€ 435
Low-temperature protection (only RR).....	€ 135	€ 165
Reference container .....	€ 30	€ 50
BioLine divider kit for aluminium drawer (length and cross dividers) ...	N/A	€ 50
Shelf supporters (additional).....	N/A	€ 35
DIN-Kit .....	€ 165	N/A
Noise reduction kit .....	€ 165	€ 195

# Products and Prices · BioCompact II



## BioCompact II - Refrigerators

RR210 (white).....	€ 1,780
RR210 (stainless).....	€ 1,890
RR310 (white).....	€ 1,940
RR310 (stainless).....	€ 2,050
RR410 (white).....	€ 2,100
RR410 (stainless).....	€ 2,210
RR610 (white).....	€ 2,660
RR610 (stainless).....	€ 2,760

## BioCompact II - Combi

RR210/RF210 (white).....	€ 3.870
RR210/RF210 (stainless).....	€ 4.090
RR310/RF210 (white).....	€ 4.030
RR310/RF210 (stainless).....	€ 4.250

## BioCompact II - Freezers

RF210 (white).....	€ 1,890
RF210 (stainless).....	€ 2,000
RF310 (white).....	€ 2,050
RF310 (stainless).....	€ 2,160
RF410 (white).....	€ 2,210
RF410 (stainless).....	€ 2,320
RF610 (white).....	€ 2,960
RF610 (stainless).....	€ 3,060

## Additional equipment and fittings

	Factory-fitted	Supplied separately
BioLine aluminium drawer (length/cross dividers) (610 RR).....	€ 165	€ 195
BioLine aluminium drawer (length/cross dividers) (420 mm).....	€ 165	€ 195
BioLine aluminium drawer (length/cross dividers) (300 mm).....	€ 155	€ 185
BioLine ABS drawer (length/cross dividers) (420 mm).....	€ 80	€ 100
BioLine stainless steel drawer 30 kg (610).....	€ 165	€ 195
BioLine stainless steel drawer 40 kg (610).....	€ 220	€ 250
BioLine dividers for stainless steel drawers (1 set).....	€ 60	€ 90
BioLine wire basket with plastic coating (430 mm).....	€ 50	€ 70
BioLine wire basket with plastic coating (300 mm).....	€ 45	€ 65
BioLine perforated shelf in stainless steel (610).....	€ 80	€ 100
BioLine perforated shelf in stainless steel (430 mm).....	€ 70	€ 90
BioLine perforated shelf in stainless steel (300 mm).....	€ 65	€ 85
BioLine wire shelf in stainless steel (610).....	€ 55	€ 75
BioLine wire shelf in stainless steel (430 mm).....	€ 50	€ 70
BioLine wire shelf in stainless steel (300 mm).....	€ 45	€ 65
BioLine wire shelf with plastic coating (610).....	€ 40	€ 60
BioLine wire shelf with plastic coating (430 mm).....	€ 30	€ 50
BioLine wire shelf with plastic coating (300 mm).....	€ 25	€ 45
Door hinge - on right or left side.....	€ 0	N/A
Chart recorder.....	€ 650	N/A
Chart recorder, paper - 100 pcs.....	N/A	€ 110
Chart recorder, pens - 1 pcs.....	N/A	€ 45
Legs or castors/wheels (only Combi/410/610).....	€ 0	€ 110
Legs or castors/wheels (only 210/310).....	€ 90	€ 110
Castors, 360° swivel (only Combi/410/610).....	€ 40	€ 150
Castors, 360° swivel (only 210/310).....	€ 125	€ 150
Wall mounting (Combi/210/310/410).....	€ 180	€ 200
Combination kit (only 210/310).....	€ 110	€ 160
60 Hz compressor.....	€ 0	N/A
Glass door (Combi/210/310/410) (only RR).....	€ 165	N/A
Glass door (610) (only RR).....	€ 230	N/A
Low-temperature protection (only RR).....	€ 135	€ 165
Reference container.....	€ 30	€ 50
Pedal door opener (410/610).....	€ 110	€ 150
BioLine divider kit for aluminium drawer (length and cross dividers) ...	N/A	€ 50
Shelf supporters (additional) (610).....	N/A	€ 35
DIN-Kit.....	€ 165	N/A

Prices exclude freight and import duties

# Codes ExGuard/BioUltra/BioPlus/BioMidi

## ER 600 D CG

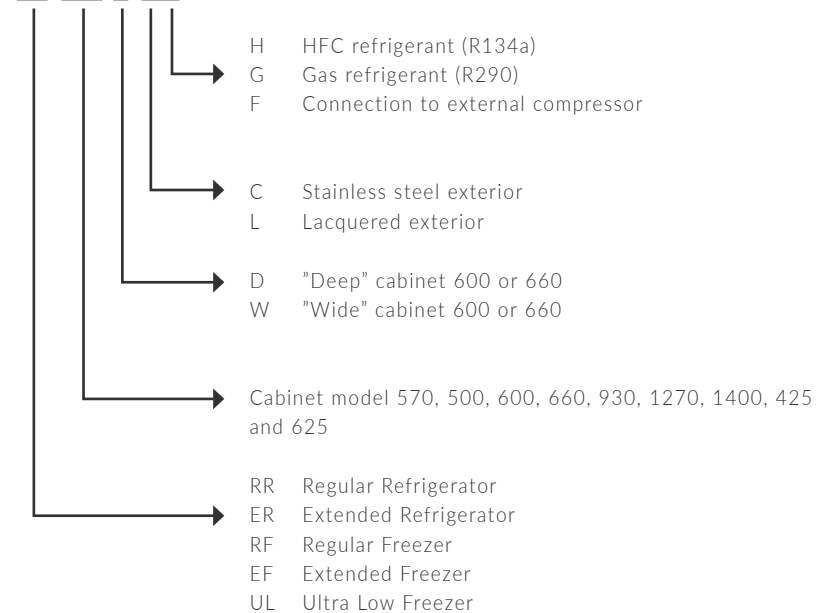

## Option codes

- 10 Solid door
- 11 Glass door
- 20 Right hinged
- 21 Left hinged
- 29 Levelling castor (BioUltra)
- 30 Wheels/castors 125 mm
- 31 Castors - 360° castors, 2 w/brakes
- 32 Recessed wheels (BioMidi)
- 33 Wheels/castors 109 mm
- 35 Legs H=100/135 mm
- 36 Legs H=135/200 mm
- 37 Legs H=185/250 mm
- 38 Prepared for mounting on a plinth
- 41 E-sensor
- 50 Chart recorder
- 69 DIN kit (only ER/RR)
- 70 Draught shield, hinged
- 79 Water cooled condenser - Hybrid (Only BioUltra)
- 80 Dual refrigeration (Only W/1270/1400)
- 81 Low-temperature protection
- 82 60 Hz compressor
- 84 Noise reduction kit (only 425, 625 units)

## Option codes

- ..A # of aluminium drawers
- ..R # of stainless steel drawer 30 kg
- ..S # of stainless steel drawer 40 kg
- ..C # of divider set in stainless steel
- ..P # of perforated shelf in stainless steel
- ..T # of wire shelf in stainless steel
- ..TTT # of wire shelf in stainless steel, draught shield
- ..N # of wire shelf with plastic coating
- ..V # of liquid containers incl. holder

Item number	Description	Item number	Description
98-630-	ExGuard ER	88-500-	BioPlus 500
98-631-	ExGuard ER Glass door	88-600-	BioPlus 600D
88-570-	BioUltra UL570	88-601-	BioPlus 600W
88-425-	BioMidi 425	88-604-	BioPlus EF600W
88-426-	BioMidi EF425	88-660-	BioPlus 660D
88-625-	BioMidi 625	88-661-	BioPlus 660W
		88-662-	BioPlus EF660W
		88-930-	BioPlus 930
		88-270-	BioPlus 1270
		88-400-	BioPlus 1400

# Codes for BioCompact II

bioline

## II RR 210 LH

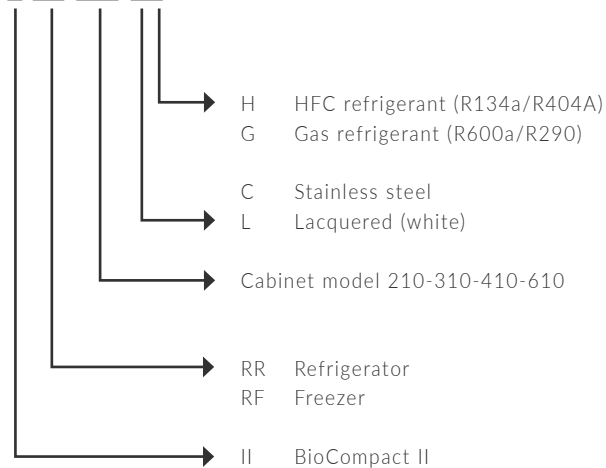

## Option codes

- 10 Solid door
- 11 Glass door
- 20 Right hinged, self-closing
- 21 Left hinged, self-closing
- 30 Wheels/castors 125mm, 2 w/brakes
- 31 Castors - 360° castors, 2 w/brakes
- 33 Wheels/castors 109mm
- 34 Wheels/skids (only 210/310 units)
- 35 Legs H=100/135 mm
- 36 Legs H=135/200 mm
- 38 Prepared for mounting on a plinth
- 39 Skids (only 210/310 units)
- 41 E-sensor
- 50 Chart recorder
- 69 DIN kit (only BioCompact II RR)
- 81 Low-temperature protection
- 82 60 Hz compressor
- 90 Combination kit
- 91 Wall mounting

## Option codes

- ..A # of aluminium drawers
- ..AA # of aluminium drawers 300 mm
- ..E # of ABS drawer
- ..R # of stainless steel drawer 30 kg (610)
- ..S # of stainless steel drawer 40 kg (610)
- ..C # of divider set in stainless steel
- ..M # of wire baskets in white plastic coating
- ..MM # of wire baskets in white plastic coating 300 mm
- ..P # of perforated shelf in stainless steel
- ..PP # of perforated shelf in stainless steel 300 mm
- ..T # of wire shelf in stainless steel
- ..TT # of wire shelf in stainless steel 300 mm
- ..W # of wire shelves in white plastic coating
- ..WW # of wire shelves in white plastic coating 300 mm
- ..N # of wire shelves in grey plastic coating
- ..V # of liquid containers incl. holder

## BioCompact II

- 88-250- II RR210
- 88-251- II RR210 glass door
- 88-252- II RF210
- 88-350- II RR310
- 88-351- II RR310 glass door
- 88-352- II RF310
- 88-450- II RR410
- 88-451- II RR410 glass door
- 88-452- II RF410
- 88-260- II RR210/II RF210
- 88-260- II RR210/II RR210
- 88-262- II RR310/II RF210
- 88-611- II RR610
- 88-613- II RR610 glass door
- 88-612- II RF610

# Power consumption (kWh/24h)

<b>BioUltra -86</b>		R290	R404a
<b>UL570</b>	Solid door	10.5	12.2

<b>ExGuard - ER</b>		R290
<b>ER600 W</b>	Solid door	1.62
	Glass door	2.08

<b>BioPlus - ER</b>		R290	R134a
<b>ER500</b>	Solid door	1.26	1.37
	Glass door	1.67	1.88
<b>ER600D</b>	Solid door	1.26	1.30
	Glass door	1.71	1.64
<b>ER660D</b>	Solid door	1.18	1.32
	Glass door	1.69	1.84
<b>ER600W</b>	Solid door	1.35	1.52
	Glass door	1.65	1.89
	Dual compressor solid door	-	-
	Dual compressor glass door	-	2.79
<b>ER660W</b>	Solid door	1.28	1.42
	Glass door	1.78	1.90
	Dual compressor solid door	2.20	2.29
	Dual compressor glass door	-	-
<b>ER930</b>	Solid door	2.10	2.79
	Glass door	2.81	2.80
<b>ER1270</b>	Solid door	2.50	2.85
	Glass door	3.48	3.39
	Dual compressor solid door	2.57	-
	Dual compressor glass door	-	5.09
<b>ER1400</b>	Solid door	2.56	2.80
	Glass door	3.72	4.16
	Dual compressor solid door	-	2.83
	Dual compressor glass door	4.47	3.90



# Power consumption (kWh/24h)



BioPlus - RF/EF		R290	R404a
<b>RF500</b>	Solid door	3.83	4.78
<b>RF600D</b>	Solid door	4.03	4.60
<b>RF660D</b>	Solid door	4.23	4.91
<b>RF600W</b>	Solid door	4.07	4.63
	Dual compressor solid door	5.67	-
<b>RF660W</b>	Solid door	4.46	5.07
	Dual compressor solid door	6.02	6.77
<b>RF930</b>	Solid door	6.12	6.28
<b>RF1270</b>	Solid door	7.97	7.48
	Dual compressor solid door	7.97	8.89
<b>RF1400</b>	Solid door	8.39	8.08
	Dual compressor solid door	8.39	9.45
<b>EF600W</b>	Solid door	8.86	9.13
	Water cooling solid door	-	7.93
	Dual compressor solid door	12.21	12.70
<b>EF660W</b>	Solid door	9.02	9.46
	Dual compressor solid door	12.87	12.92

BioMidi - RR		R290	R134a
<b>RR425</b>	Solid door	1.27	1.19
	Glass door	1.63	1.87
<b>RR625</b>	Solid door	1.30	1.33
	Glass door	1.64	1.82

BioMidi - RF/EF		R290	R404a
<b>RF425</b>	Solid door	3.61	4.45
<b>RF625</b>	Solid door	4.03	4.52
<b>EF425</b>	Solid door	8.93	9.40

# Power consumption (kWh/24h)

BioCompact II - RR		R600a	R134a
<b>RR210</b>	Solid door	0.61	0.68
	Glass door	0.98	1.22
<b>RR310</b>	Solid door	0.63	0.79
	Glass door	0.98	1.30
<b>RR410</b>	Solid door	0.73	0.96
	Glass door	1.44	1.58
<b>RR610</b>	Solid door	1.15	1.36
	Glass door	1.9	2.02
<b>RR310/RF210 combi</b>	Solid door	2.14	2.63
<b>RR210/RF210 combi</b>	Solid door	2.19	2.74

BioCompact II - RF		R600a	R134a	R290
<b>RF210</b>	Solid door	1.53	1.95	-
<b>RF310</b>	Solid door	1.69	1.99	-
<b>RF410</b>	Solid door	2.13	2.66	-
<b>RF610</b>	Solid door	-	-	3.88
<b>RR210/RF210 combi</b>	Solid door	2.14	2.63	-
<b>RR310/RF210 combi</b>	Solid door	2.19	2.74	-

**RF610** Solid door R404a: 4.2

# Module definition



Model	No. of modules	Distances between modules mm
BioUltra UL570	-	12,5
ExGuard 600W	48	25
BioPlus 500*	52	25
BioPlus 600D*	24	50
BioPlus 660D*	27	50
BioPlus 600W*	24	50
BioPlus 660W*	27	50
Bioplus 930*	52	25
BioPlus 1270*	2 x 24	50
BioPlus 1400*	2 x 27	50
BioMidi 425*	25	50
BioMidi 625*	25	50
BioCompact II 210	4 x 430 mm + 3 x 300 mm	50
BioCompact II 210/210	8 x 430 mm + 6 x 300 mm	50
BioCompact II 310	11 x 430 mm + 3 x 300 mm	50
BioCompact II 310/210	15 x 430 mm + 6 x 300 mm	50
BioCompact II 410	22 x 430 mm + 3 x 300 mm	50
BioCompact II 610*	24	50

**BioCompact II (210, 310 and 410)**

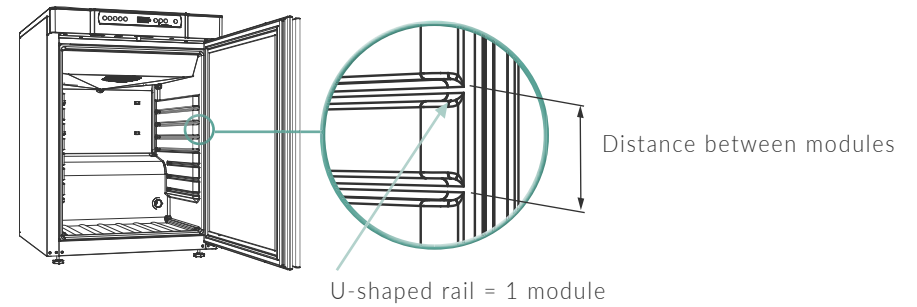



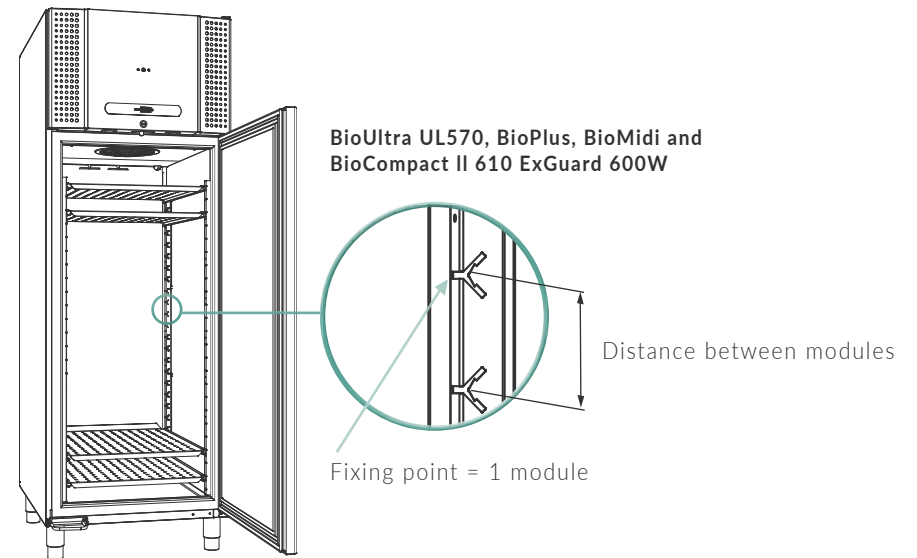



**BioUltra UL570, BioPlus, BioMidi and BioCompact II 610 ExGuard 600W**

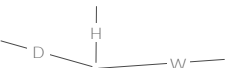

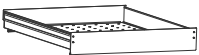
\*Note that reference container (when selected) takes up space corresponding to 2 modules.

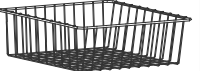
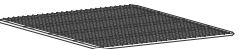
# Dimensions, drawers and shelves

Type	ABS drawer	Aluminium drawer	Stainless steel drawer 30 kg	Stainless steel drawer 40 kg	Wire basket**	Wire shelf	Perforated shelf
							
Module size	2	2	2	2	3	1	1
ExGuard 600W	-	-	-	492/625/60 [12]	-	650/530 [48]	647/500 [48]
570	-	-	-	-	-	-	619/574 [-]
210/310/410 ***	429/395/68 [2/5/11]	396/419/60 [2/5/11]	-	-	426/386/139 [1/3/7]	486/433 [4/11/22]	483/433 [4/11/22]
210/310/410 ****	-	396/296/60 [2/2/2]	-	-	442/260/209 [1/1/1]	486/300 [3/3/3]	483/302 [3/3/3]
610	-	504/626/60 [12]	505/625/60 [12]	492/625/60 [12]	-	530/650 [24]	528/630 [24]
425	-	409/508/60 [12]	410/505/60 [12]	397/505/60 [12]	-	435/530 or 433/501*[25]	435/510 [25]
625	-	624/496/60 [12]	626/505/60 [12]	612/505/60 [12]	-	650/530 or 650/500*[25]	650/500 [25]
500	-	376/576/60 [13]	379/575/60 [13]	364/575/60 [13]	-	400/600 or 400/570* [52]	399/580 [52]
600D/660D/ 1270/1400	-	504/626/60 [12/13/24/26]	505/625/60 [11/13/22/26]	492/625/60 [12/13/24/26]	-	530/650 or 529/621* [24/27/48/54]	528/630 [24/27/48/54]
930	-	-	-	595/748/60 [13]	-	602/785 [52]	600/784 [52]
600/660W	-	624/496/60 [12/13]	626/501/60 [11/13]	612/505/60 [12/13]	-	650/530 or 650/500* [24/27]	647/500 [24/27]

[ ]: maximum numbers that can be fitted into the cabinet.  
Dimensions: W x D x H mm

\* Shelf dimension when combined with draught shield (option code 70).  
\*\* 120° door opening required

\*\*\*: Drawer 420 mm  
\*\*\*\*: 300 mm

Note that reference container (when selected) takes up space corresponding to 2 modules. (BioMidi, BioPlus, BioCompact II 610)

# Loading heights

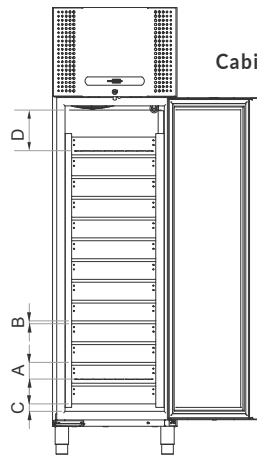

Cabinets with drawers

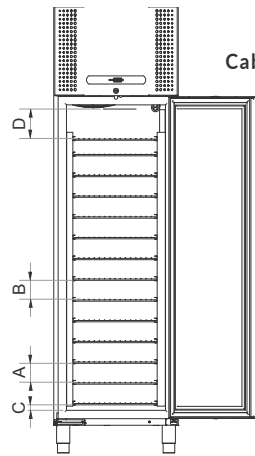

Cabinets with shelves

- A = Loading height in drawer/loading height between shelves
- B = Gap between drawers/shelves
- C = Distance to cabinet bottom from cabinet with drawer/shelf in lowest position
- D = Loading height in top drawer/shelf (to load line)

Given as: A\B\C\D mm - interior is placed with minimum distance between each drawer/shelf. See page 75 for distance between modules.

Model	Aluminium drawer	Stainless steel drawer 30 kg	Stainless steel drawer 40 kg	Wire basket	Wire shelf	Perforated shelf
210	80/14/93/83	-	-	430mm: 145/8/-/207, 300mm: 271/8/8/-	39/39/101/66	37/37/96/68
310	80/14/93/122	-	-	430mm: 145/8/-/246, 300mm: 271/8/8/-	39/39/101/105	37/37/96/107
410	80/14/93/159	-	-	430mm: 145/8/-/283, 300mm: 271/8/8/-	39/39/101/142	37/37/96/144
610	80/14/74/128	84/24/19/164	84/24/50/132	-	39/39/34/98	30/30/38/94
425	80/14/37/164	84/24/55/201	84/24/37/169	-	39/39/25/135	30/30/20/131
625	80/14/37/164	84/24/55/201	84/24/37/167	-	39/39/25/135	30/30/20/131
500	80/14/37/192	84/24/31/203	84/24/37/196	-	39/39/23/138	30/30/22/133
570	-	-	-	-	-	-
ExGuard 600W	-	-	84/24/24/157	-	39/39/63/122	30/30/57/119
600/660D	80/14/23/154	84/24/42/188	84/24/24/157	-	39/39/63/122	30/30/57/119
600/660W	80/14/23/154	84/24/42/188	84/24/24/157	-	39/39/63/122	30/30/57/119
930	-	-	84/24/37/166	-	39/39/23/123	30/30/22/119
RF930	-	-	84/24/37/152	-	39/39/23/109	39/39/23/105
1270	80/14/23/152	84/24/42/188	84/24/24/156	-	39/39/63/122	30/30/57/119
1400	80/14/23/152	84/24/42/188	84/24/24/156	-	39/39/63/122	30/30/57/119

# Dimensions, cabinets

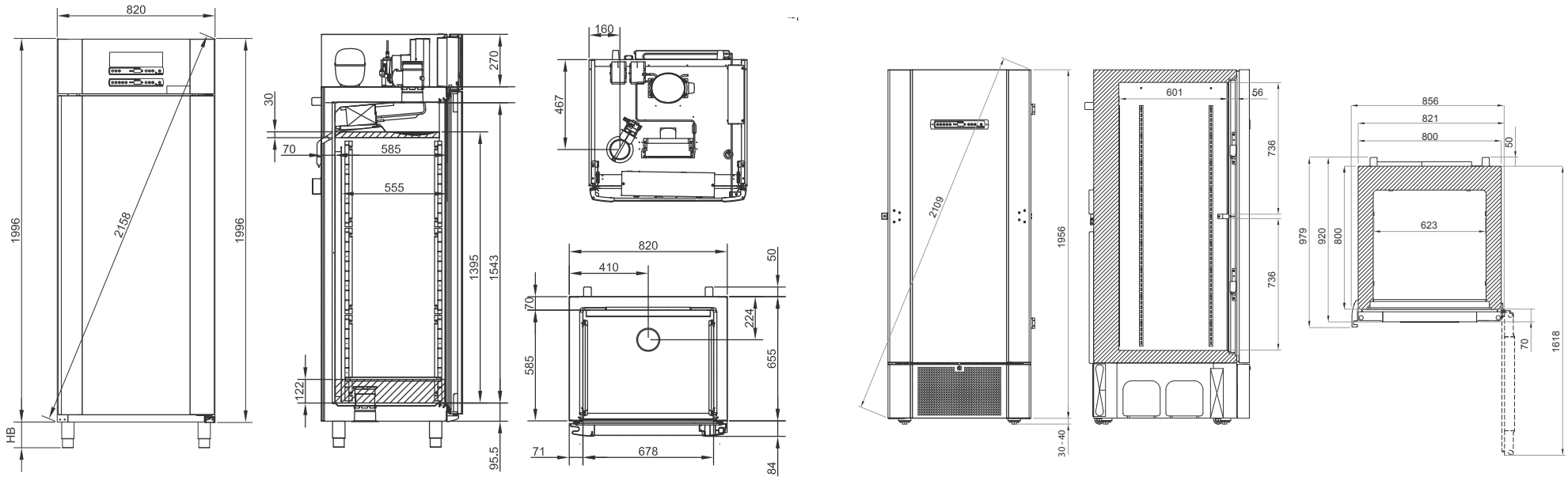

## ExGuard 600W

HB code: 30, 31, 33, 35, 36, 37

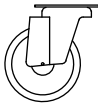
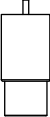
Wheels/castors		Legs	
			
Code	HB (mm)	Code	HB* (mm)
30	125	35	100 - 135
31	125	36	135 - 200
33	109	37	185 - 250

## BioUltra UL570

HB code: 29

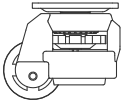
Levelling castors	
	
Code	HB (mm)
29	30-40

# Dimensions, cabinets

bioline

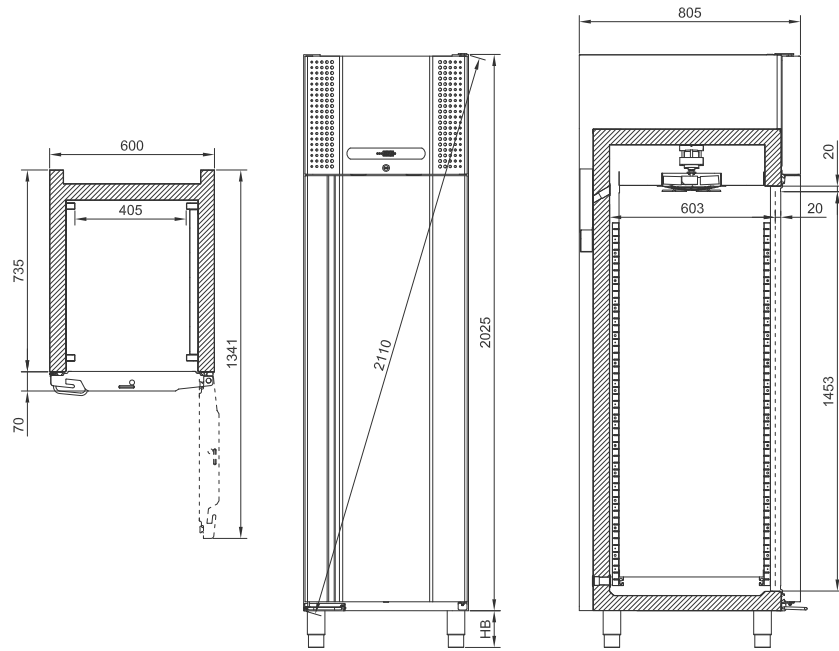

## BioPlus 500

HB code: 30, 31, 33, 35, 36, 37 or 38

Note: 20 mm air passage is 25 mm when cabinet is equipped with draught shield (option 70)

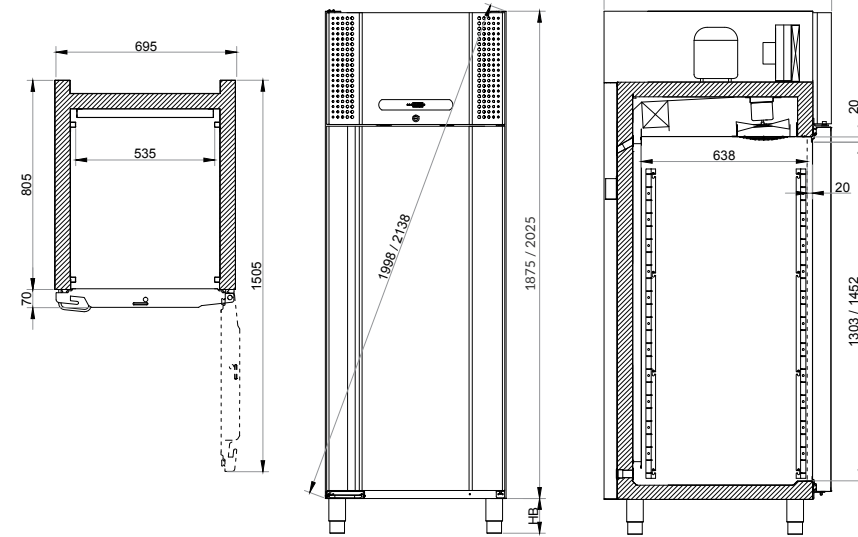



## BioPlus 600/660D

HB code: 30, 31, 33, 35, 36, 37 or 38

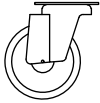
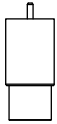
Note: 20 mm air passage is 25 mm when cabinet is equipped with draught shield (option 70)

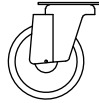
Wheels/castors		Legs		Plinth mounting	
					
Code	HB (mm)	Code	HB (mm)	Code	HB (mm)
30	125	35	100 - 135	38	0
31	125	36	135 - 200		
33	109	37	185 - 250		

Wheels/castors		Legs		Plinth mounting	
					
Code	HB (mm)	Code	HB (mm)	Code	HB (mm)
30	125	35	100 - 135	38	0
31	125	36	135 - 200		
33	109	37	185 - 250		

# Dimensions, cabinets

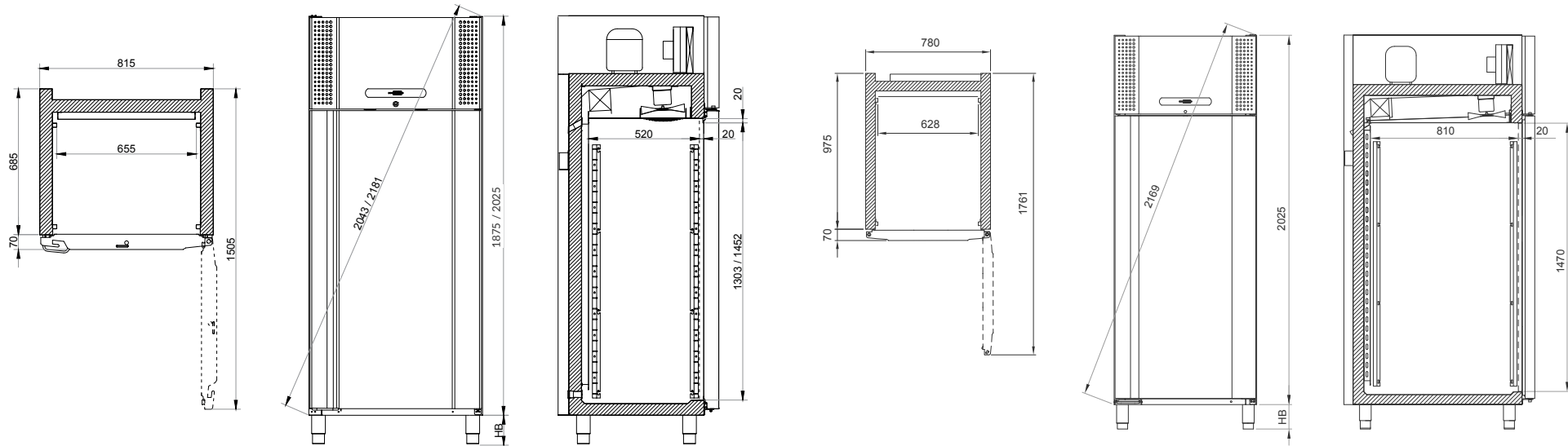

## BioPlus 600/660W

HB code: 30, 31, 33, 35, 36, 37 or 38

Note: 20 mm air passage is 25 mm when cabinet is equipped with draught shield (option 70)

Width on EF and PF models are 22 mm greater than given on the drawing due to the handle

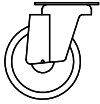
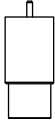
Wheels/castors		Legs		Plinth mounting	
					
Code	HB (mm)	Code	HB (mm)	Code	HB (mm)
30	125	35	100 - 135	38	0
31	125	36	135 - 200		
33	109	37	185 - 250		

## BioPlus 930

HB code: 30, 31, 33, 35, 36, 37 og 38

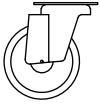
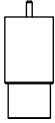
Wheels/castors		Legs		Plinth mounting	
					
Code	HB (mm)	Code	HB (mm)	Code	HB (mm)
30	125	35	100 - 135	38	0
31	125	36	135 - 200		
33	109	37	185 - 250		



# Dimensions, cabinets

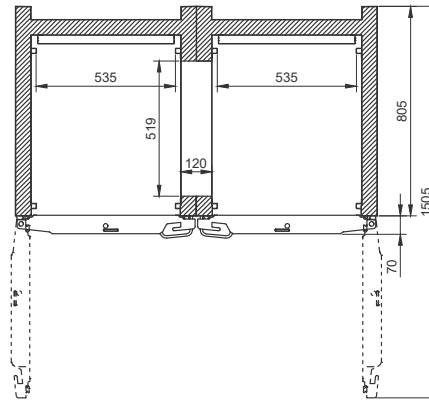
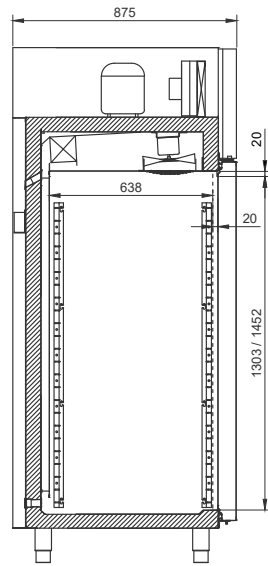
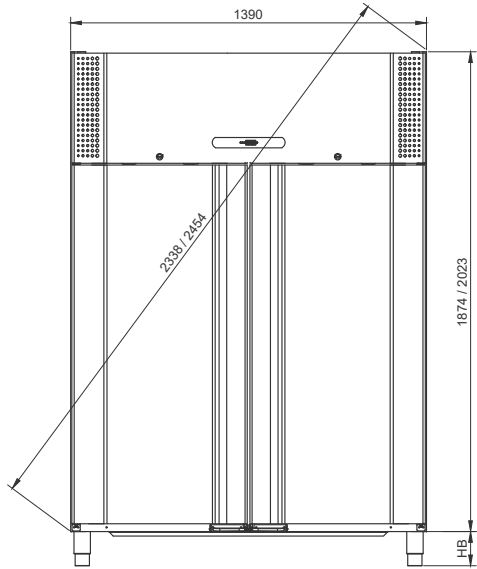
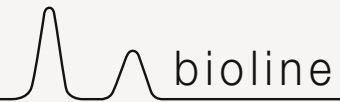

## BioPlus 1270/1400

HB code: 31, 33, 35, 36, 37 or 38

Note: 20 mm air passage is 25 mm when cabinet is equipped with draught shield (option 70)

Wheels/castors		Legs		Plinth mounting	
Code	HB (mm)	Code	HB (mm)	Code	HB (mm)
31	125	35	100 - 135	38	0
33	109	36	135 - 200		
		37	185 - 250		

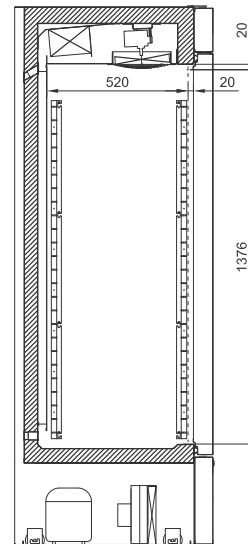
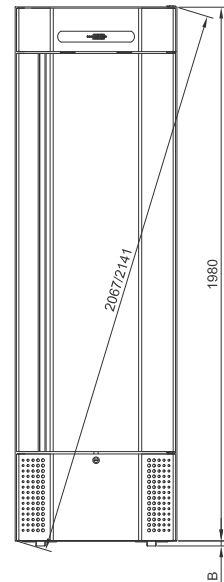
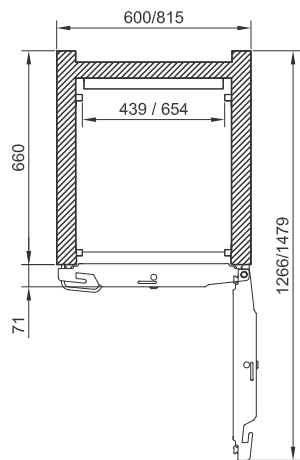

## BioMidi 425/625

HB code: 32 or 38

Note: 20 mm air passage is 25 mm when cabinet is equipped with draught shield (option 70)

Width on EF and PF models are 22 mm greater than given on the drawing due to the handle

Recessed wheels		Plinth mounting	
Code	HB (mm)	Code	HB (mm)
32	20	38	0

# Dimensions, cabinets

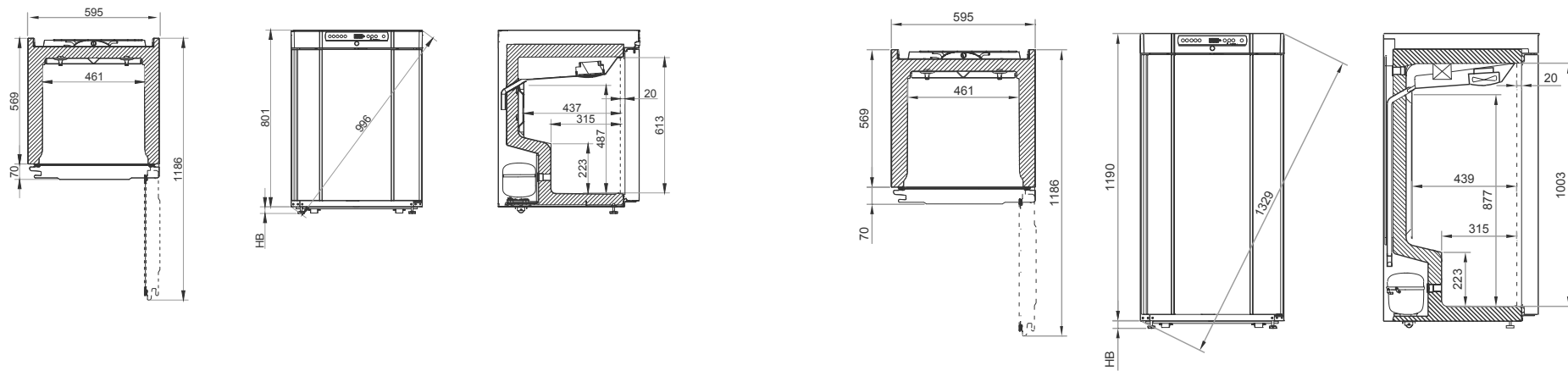





## BioCompact II 210

HB code: 30, 31, 33, 34, 35, 36, 38 or 39

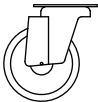
## BioCompact II 310

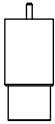
HB code: 30, 31, 33, 34, 35, 36, 38 or 39

Wheels/castors		Wheels/skids		Legs		Plinth mounting		Skids	
									
Code	HB (mm)	Code	HB (mm)	Code	HB (mm)	Code	HB (mm)	Code	HB (mm)
30	125	34	30	35	100 - 135	38	0	39	30
31	125			36	135 - 200				
33	109								

# Dimensions, cabinets

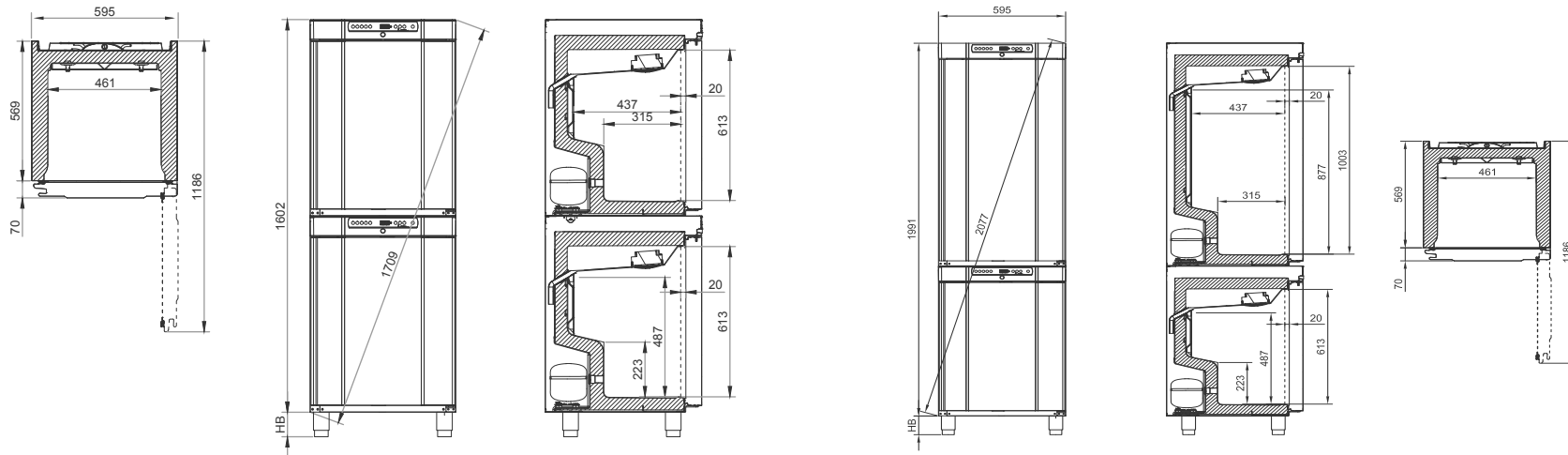

## BioCompact II 210/210

HB code: 30, 31, 33, 35 36 or 38

## BioCompact II 310/210

HB code: 30, 31, 33, 35, 36 or 38

Wheels/castors		Legs		Plinth mounting	
Code	HB (mm)	Code	HB (mm)	Code	HB (mm)
30	125	35	100 - 135	38	0
31	125	36	135 - 200		
33	109				

Wheels/castors		Legs		Plinth mounting	
Code	HB (mm)	Code	HB (mm)	Code	HB (mm)
30	125	35	100 - 135	38	0
31	125	36	135 - 200		
33	109				

# Dimensions, cabinets

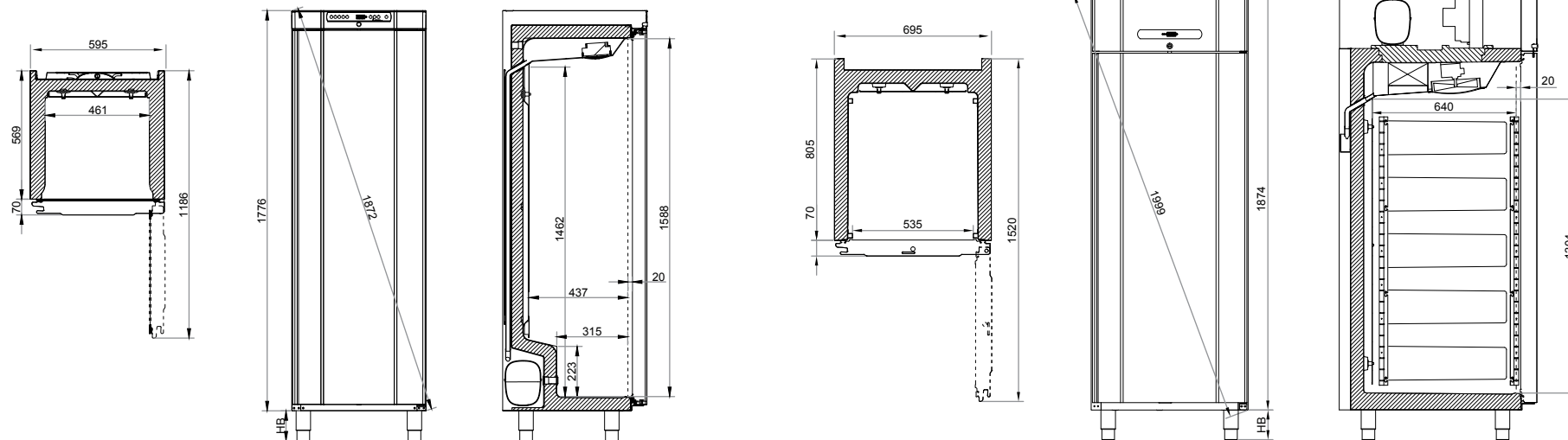

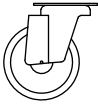
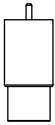

## BioCompact II 410

HB code: 30, 31, 33, 35 36 or 38

Wheels/castors		Legs		Plinth mounting	
					
Code	HB (mm)	Code	HB (mm)	Code	HB (mm)
30	125	35	100 - 135	38	0
31	125	36	135 - 200		
33	109				

## BioCompact II 610

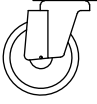
HB code: 30, 31, 33, 35, 36 or 38

Wheels/castors		Legs		Plinth mounting	
					
Code	HB (mm)	Code	HB (mm)	Code	HB (mm)
30	125	35	100 - 135	38	0
31	125	36	135 - 200		
33	109				

# BIOBASIC 210, 310, 410, 600



## Internal and external ATEX

The BIOBASIC range provides full ATEX compliance – both internal and external – at no extra charge.

BIOBASIC cabinets comply with EN/IEC 60079-15, electrical apparatus for use in Category 3, Zone 2 locations where explosive gas atmospheres may be present. Enabling placement of cabinets within actual work zones, rather than at a remote location, as would be required with only internal ATEX compliance.

# BIOBASIC RR 210, 310, 410, 600



## Refrigerators

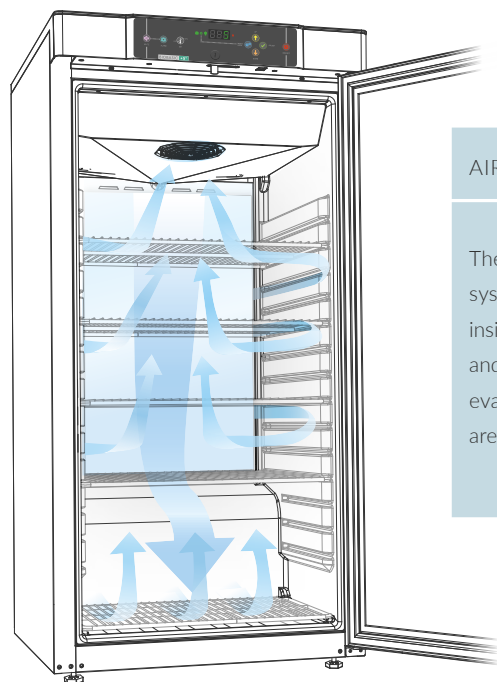

### AIR DISTRIBUTION

The unique forced air distribution system makes sure the temperature inside the cabinet remains stable and uniform. With the finned tube evaporator placed in the top, there are no cold walls in the cabinet.

Technical specifications	RR210	RR310	RR410	RR600
Temperature range	+2/+15°C			
Ambient temperature range	Solid door +10/+35 °C / Glass door +10/+32°C			Solid door +10/+43 °C
Control Unit	Bespoke user friendly BIOBASIC control unit featuring acoustic/visual temperature and door alarms, voltage free contact and offset function.			
Material: Interior Exterior	Polystyrene lining White lacquered steel			Stainless steel White lacquered steel
Dimensions mm (W x D x H)	595 x 640 x 831	595 x 640 x 1220	595 x 640 x 1876	700 x 895 x 2125
Gross volume/ Net volume	125 litres 104 litres	218 litres 189 litres	346 litres 312 litres	610 litres 536 litres
Plastic coated wire shelves	3 total number	4 total number	6 total number	4 total number
Refrigerant	R600a			R290
Energy consumption	0,61 kWh/24h	0,63 kWh/24h	0,73 kWh/24h	1,55 kWh/24h
Energy consumption glass door	0,98 kWh/24h	0,98 kWh/24h	1,44 kWh/24h	
Noise level	36,5 dB(A)	38,6 dB(A)	35,1 dB(A)	44,2 dB(A)
Base	Wheels /skids	Wheels /skids	Height-adjustable legs	Height-adjustable legs
Air system	Gram BioLine ventilated air distribution system			
Defrost system	Automatic smart defrost with re-evaporation of defrost water			
Solid door item number	782530001	783530001	784530001	786000001
Glass door item number	782540001	783540001	784540001	-
Connection	230 V, 50 Hz	230 V, 50 Hz	230 V, 50 Hz	230 V, 50 Hz
Access ports	1	1	1	2
ATEX-marking	 II 3G Ex nA nC nL IIB T6 Gc DTI 21ATEX0161X	II 3G Ex nA nC nL IIB T6 Gc DTI 21ATEX0161X	II 3G Ex nA nC nL IIB T6 Gc DTI 21ATEX0161X	II 3G Ex ec nC ic IIB T4 Gc DTI 19ATEX0114X
Price solid door	€ 1.360	€ 1.530	€ 1.690	€ 2.560
Price glass door	€ 1.625	€ 1.795	€ 1.955	-

# BIOBASIC RF 210, 310, 410, 600

## Freezers



Technical specifications	RF 210	RF 310	RF 410	RF 600
Temperature range	-25/-5°C			
Ambient temperature range	Solid door +10/+35 °C			Solid door +10/+43 °C
Control Unit	Bespoke user friendly BIOBASIC control unit featuring acoustic/visual temperature and door alarms, voltage free contact and offset function.			
Material: Interior Exterior	Polystyrene lining White lacquered steel			Stainless steel White lacquered steel
Dimensions mm (W x D x H)	595 x 640 x 831	595 x 640 x 1220	595 x 640 x 1876	700 x 895 x 2125
Gross volume/ Net volume	125 litres 104 litres	218 litres 189 litres	346 litres 312 litres	610 litres 536 litres
Plastic coated wire shelves	3 total number	4 total number	6 total number	4 total number
Refrigerant	R600a			R290
Energy consumption	1,1 kWh/24h	1,3 kWh/24h	1,6 kWh/24h	3,9 kWh/24h
Noise level	39,7 dB(A)	39,6 dB(A)	38,6 dB(A)	48,6 dB(A)
Base	Wheels /skids	Wheels /skids	Height-adjustable legs	Height-adjustable legs
Air system	Gram BioLine ventilated air distribution system			
Defrost system	Automatic smart defrost with re-evaporation of defrost water			
Gram BIOBASIC Item number	782550001	783550001	784550001	786020001
Connection	230 V, 50 Hz			
Access port	1	1	1	2
ATEX-marking 	II 3G Ex nA nC nL IIB T3 Gc DTI 21ATEX0161X	II 3G Ex nA nC nL IIB T3 Gc DTI 21ATEX0161X	II 3G Ex nA nC nL IIB T3 Gc DTI 21ATEX0161X	II 3G Ex ec nC ic IIB T1 Gc DTI 19ATEX0114X
Price	€ 1.470	€ 1.640	€ 1.800	€ 2.760



### Top panel with BIOBASIC control unit

The BIOBASIC control unit is specifically developed for users of BIOBASIC. Among its many features are acoustic / visual temperature and door alarms, voltage free contact (NO/NC) for remote temperature and power failure alarm, monitoring and read out of highest and lowest temperature, controller key pad lock, off set function.

Door lock comes as standard with two keys.



### Performance is key

With the finned tube evaporator placed in the top separated from the storage compartment there is no cold walls in the cabinet

Utilizing clever design and quality components, the BIOBASIC range manages to offer cost-effective performance on a small footprint.

BIO

The BIOBASIC range offers cost-effective biostorage solutions for a host of applications

With temperature alarms, internal and external ATEX, no cold walls and a user-friendly interface, the BIOBASIC range provides an exceptional selection of features in a very small package.

With four sizes to choose from, the BIOBASIC range is well suited for use in confined spaces where performance, features and value are paramount.

- All available as refrigerators or freezers.



BIOBASIC



Biostorage you can depend on

**Gram Commercial,**  
**filial af Hoshizaki Europe BV, Holland**  
**Aage Grams Vej 1 // DK-6500 Vojens // Denmark**  
**Tel: +45 73 20 13 00 // Fax: +45 73 20 13 01**  
**info@gram-bioline.com**

United Kingdom  
Gram Commercial  
2 The Technology Centre // London Road // Swanley // Kent BR8 7AG  
Tel.: +44 1322 476 410 // Fax: +44 1322 476 409  
info@gram-bioline.com

Germany  
Gram Commercial  
c/o Andersen Partners Business Center  
Alsterarkaden 13 // D-20354 Hamburg  
Tel.: +49 5066 69 49 375 // Fax: +49 5066 69 49 376  
info@gram-bioline.com

The Netherlands and Belgium  
Gram Commercial  
P/A Matix Bedrijvencentrum  
Plesmanweg 9-109 // NL-7602 PD Almelo  
Tel.: +31 546 744 130  
info@gram-bioline.com

Sweden  
Gram Commercial  
Box 5157 // S-20071 Malmö  
Tel: + 46 812 11 29 75 // Fax: + 46 81 211 29 77  
info@gram-bioline.com

Norway  
Gram Commercial  
Aage Grams Vej 1 // DK-6500 Vojens // Denmark  
Tel: + 47 23 96 79 28 // Fax: +47 23 96 79 29  
info@gram-bioline.com

France  
Gram Commercial  
120, rue Jean Jaurès  
92300 Levallois Perret  
Tel: +33 1 79 36 35 30 // Fax: +33 1 79 36 35 29  
info@gram-bioline.com

**Gram Commercial** is one of the world's prime manufacturers of high-performance refrigeration and freezer equipment for discerning professional users. We develop, manufacture and market this technology for customers in Europe, the Middle East and Asia, operating from our administration and manufacturing facilities in Denmark. This is all backed by branches in the UK, Germany, the Netherlands, France, Sweden and Norway and distributors throughout the world.

**www.gram-bioline.com**  
**www.gram-biobasic.com**

Copyright © 2006-2022 Gram BioLine, a division of Gram Commercial, filial af Hoshizaki Europe BV, Holland. All rights reserved.

The content of this publication is owned by Gram BioLine, unless otherwise noted, and is protected by Danish and international copyright laws and provisions. Information and images may not be used, copied or transferred without the express written permission of Gram BioLine.